

Owner's Manual

ECLIPSE GPS

GX1400GPS GX1400GPS/E (European Version)

ECLIPSE

GX1400

- Meets ITU-R M.493-13 class D DSC (Digital Selective Calling)
(European version: Meets ITU-R M.493-14)
- Input and Output of GPS information to NMEA 0183 compatible devices
- Integrated 66 Channel Internal GPS receiver (GX1400GPS and GX1400GPS/E only)
- Built in Separate Receiver for CH70 (Receiving DSC Calls)
- Automatic DSC polling of up to 6 ships GPS positions*
- Auto DSC channel selection & DSC test call
- DSC distress, individual, group, all ships, position request and position report
- Large Viewable Display, Easy to Mount, Submersible IPX8 (5 feet or 1.5 m for 30 minutes)
- Noise canceling microphone with channel change, 16/S and H/L key buttons
- GPS position and time shown on a full dot matrix display*
- Preset Key used to recall up to 10 favorite channels
- Programmable scan, priority scan, and Multi Watch (Dual Watch or Triple Watch)
- Noise cancelling microphone with channel change selection, 16/S and H/L keys
- ATIS Mode for European Inland Waterways (GX1400GPS/E only)

*External GPS device required for GX1400.



STANDARD HORIZON

Nothing takes to water like Standard Horizon

TABLE OF CONTENTS

QUICK REFERENCE	2	9 BASIC OPERATION	24
1 GENERAL INFORMATION	3	9.1 TURNING ON AND OFF THE TRANSCEIVER	24
2 PACKING LIST	3	9.2 RECEPTION	24
3 OPTIONAL ACCESSORIES	3	9.3 TRANSMISSION	24
4 ONLINE WARRANTY REGISTRATION	4	9.3.1 Transmit Power	24
5 Safety Precautions (Be Sure to Read)	4	9.4 TRANSMIT TIME-OUT TIMER (TOT)	25
6 GETTING STARTED	6	9.5 BASIC OPERATION OF THE SETUP MENU	25
6.1 ABOUT VHF RADIO	6	9.6 SIMPLEX/DUPLEX CHANNEL USE	26
6.2 SELECTING AN ANTENNA	6	9.7 CHANNEL GROUP	26
6.3 Coaxial Cable	6	9.8 NOAA WEATHER CHANNELS (in USA and Canada only)	27
6.4 DISTRESS AND HAILING (CHANNEL 16) ..	7	9.8.1 NOAA Weather Alert (USA version only)	27
6.5 CALLING ANOTHER VESSEL (CHANNEL 16 OR 9)	8	9.8.2 NOAA Weather Alert Testing	27
6.6 Accuracy of COG*	8	9.9 MULTI WATCH (TO PRIORITY CHANNEL) ...	28
7 CONTROLS AND INDICATORS	9	9.9.1 Setting up the Multi Watch Operation	28
7.1 FRONT PANEL	9	9.9.2 Starting the Dual Watch	28
7.2 MICROPHONE	11	9.10 SCANNING	29
7.3 REAR PANEL	12	9.10.1 Selecting the Scan Type	29
8 INSTALLATION	13	9.10.2 Programming Scan Memory	30
8.1 SAFETY / WARNING INFORMATION	13	9.10.3 Memory Scanning (M-SCAN)	30
8.2 LOCATION	13	9.10.4 Priority Scanning (P-SCAN)	31
8.3 MOUNTING THE RADIO	13	9.11 PRESET CHANNELS: INSTANT ACCESS	31
8.3.1 Supplied Mounting Bracket	13	9.11.1 Programming	31
8.3.2 Optional MMB-84 Flush Mount Bracket	14	9.11.2 Operation	32
8.4 ELECTRICAL CONNECTIONS	15	9.11.3 Deletion	32
8.5 CONNECTION OF EXTERNAL DEVICES TO THE RADIO	16	10 DIGITAL SELECTIVE CALLING (DSC)	33
8.5.1 Connecting the NMEA 0183/ NMEA 0183-HS to the Radio	16	10.1 GENERAL	33
8.5.2 Accessory Cables	17	10.2 DISTRESS ALERT	33
8.5.3 Connection to External GPS or Chart Plotter	17	10.2.1 Transmitting a DSC Distress Alert	33
8.5.4 GPS Input - optional SCU-31 External GPS Antenna	18	10.2.2 Receiving a Distress Alert	37
8.5.5 Connection to External Speaker	18	10.3 ALL SHIPS CALL	38
8.5.6 Connecting the SCU-38 External GPS Antenna to the Radio (GX1400GPS and GX1400GPS/E only)	18	10.3.1 Transmitting an All Ships Call	38
8.6 INITIAL SETUP REQUIRED WHEN TURNING ON THE POWER FOR THE FIRST TIME	19	10.3.2 Receiving an All Ships Call	39
8.6.1 Maritime Mobile Service Identity (MMSI)	19	10.3.3 Setting up the All Ships Call Ringer	39
8.7 CHECKING GPS CONNECTIONS (GPS STATUS DISPLAY)	20	10.4 INDIVIDUAL CALL	40
8.8 GPS CONFIGURATION	22	10.4.1 Setting up the Individual / Position Call Directory	40
8.8.1 Changing the GPS Time	22	10.4.2 Setting up Individual Call Reply	41
8.8.2 Changing the Time Area	22	10.4.3 Setting up the Individual Call Acknowledgment	42
8.8.3 Changing the Time Format	23	10.4.4 Transmitting an Individual Call	42
		10.4.5 Receiving an Individual Call	44
		10.4.6 Setting up the Individual Call Ringer	45
		10.5 GROUP CALL	46
		10.5.1 Setting up a Group Call	46
		10.5.2 Transmitting a Group Call	48
		10.5.3 Receiving a Group Call	50
		10.5.4 Setting up the Group Call Ringer	51

TABLE OF CONTENTS

10.6 POSITION REQUEST	52	11.4.4 Time Format	71
10.6.1 Transmitting a Position Request to Another Vessel	52	11.4.5 Unit Of Measure	72
10.6.2 Receiving a Position Request	55	11.4.6 Data Speed	72
10.6.3 Setting up the Position Request Ringer ...	55	11.4.7 Output Sentences	72
10.7 POSITION REPORT	55	11.5 CONFIGURATION SETUP	73
10.7.1 Transmitting a DSC Position Report Call ...	56	11.5.1 Dimmer Adjustment	73
10.7.2 Receiving a DSC Position Report Call	57	11.5.2 LCD Contrast	73
10.7.3 Setting up a Position Report Ringer	58	11.5.3 Key Beep	74
10.8 MANUAL INPUT OF THE GPS LOCATION (LAT/LON)	58	11.5.4 Soft Keys	74
10.9 AUTO POS POLLING	59	11.5.5 Reset	76
10.9.1 Setting up the Polling Call Type	59	11.5.6 Reset the USER MMSI and ATIS CODE ...	76
10.9.2 Setting up the Polling Time Interval	59	12 MAINTENANCE	79
10.9.3 Selecting Stations to be Automatically Polled	60	12.1 REPLACEMENT PARTS	79
10.9.4 Enabling/Disabling Auto POS Polling	60	12.2 FACTORY SERVICE	79
10.10 DSC TEST CALL	61	12.3 TROUBLESHOOTING CHART	80
10.10.1 Transmitting a DSC Test Call	61	13 CHANNEL ASSIGNMENTS	81
10.10.2 Receiving a DSC Test Call	62	13.1 GX1400GPS and GX1400	81
10.11 DSC LOG OPERATION	63	13.2 GX1400GPS/E	84
10.11.1 Reviewing a Logged Transmitted Call	63	14 SPECIFICATIONS	86
10.11.2 Reviewing a Logged DSC Distress Call	63	14.1 GX1400 DIMENSIONS	88
10.11.3 Reviewing a Logged Other Calls	64	15 FCC RADIO LICENSE INFORMATION	89
10.11.4 Deleting Calls from the "DSC LOG" Directory	65	15.1 STATION LICENSE	89
11 SETUP MENU	66	15.2 RADIO CALL SIGN	89
11.1 DSC SETUP	66	15.3 CANADIAN SHIP STATION LICENSING ...	89
11.1.1 Individual Directory	66	15.4 FCC / IC INFORMATION	89
11.1.2 Individual Reply	66	16 FCC NOTICE	90
11.1.3 Individual Acknowledgement	66	TEMPLATE for the GX1400 Series	93
11.1.4 Individual Ringer	66		
11.1.5 Group Directory	66		
11.1.6 Auto Position Polling Call Type	67		
11.1.7 Auto Position Polling Interval Time	67		
11.1.8 Auto Channel Switching Time	67		
11.1.9 DSC Beep	67		
11.2 CHANNEL SETUP	67		
11.2.1 Channel Group (Band Selection)	67		
11.2.2 Weather Alert (USA version only)	68		
11.2.3 Multi Watch	68		
11.2.4 Scan Memory	68		
11.2.5 Scan Type	68		
11.2.6 Scan Resume	68		
11.2.7 Priority Channel	69		
11.2.8 Sub Channel	69		
11.3 ATIS SETUP (GX1400GPS/E only)	69		
11.3.1 ATIS Code Setup (GX1400GPS/E only) ...	70		
11.3.2 ATIS CH Group	70		
11.4 GPS SETUP	71		
11.4.1 Location Format	71		
11.4.2 Time Offset	71		
11.4.3 Time Area	71		

QUICK REFERENCE

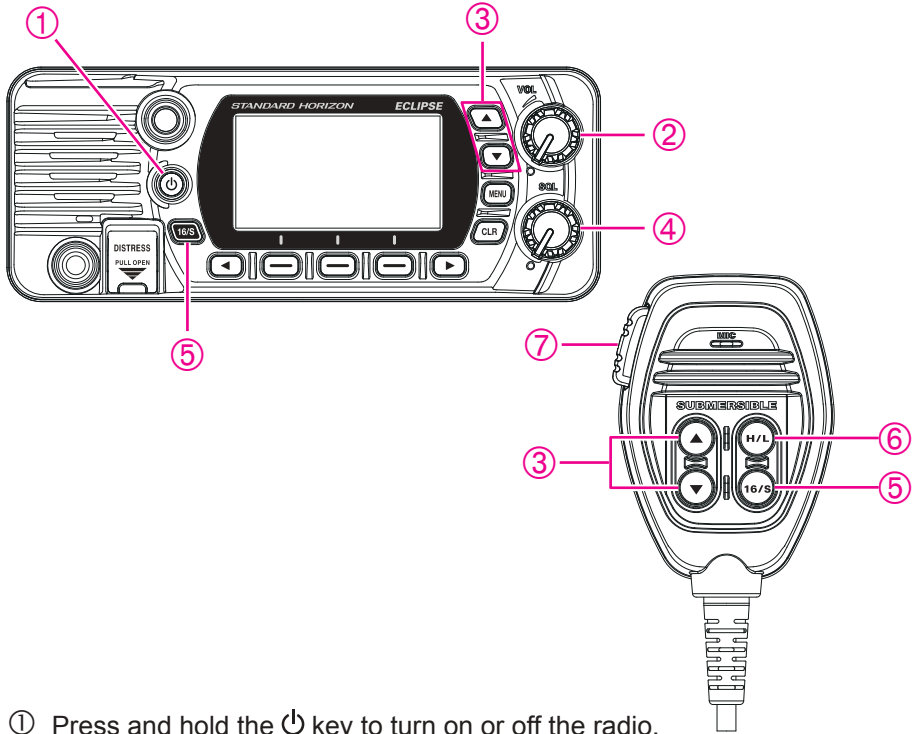

- ① Press and hold the $\text{\textcircled{P}}$ key to turn on or off the radio.
- ② Rotate the **VOL** knob to adjust the speaker audio volume.
- ③ Press the [\blacktriangle] or [\blacktriangledown] key on the radio to select the operating channel.
- ④ Move the **SQL** knob clockwise to squelch or counter clockwise to un-squelch the radio.
- ⑤ Press the [**16/S**] key on the radio to select Channel 16. Press and hold the [**16/S**] key on the radio to select the sub channel. Press again to revert to the last selected channel.
- ⑥ Press the [**H/L**] key to toggle the transmit power between High (25W) and Low (1W).
- ⑦ To transmit: place your mouth about 1" (2.5cm) away from the **MIC** hole of the microphone and speak in a normal voice level while pressing the **PTT** switch.

1 GENERAL INFORMATION

The STANDARD HORIZON **GX1400** Marine VHF/FM Marine transceiver is designed to be used in USA, International, and Canadian Marine bands. The **GX1400** series can be operated from 11 to 16 VDC and has a switchable RF output power of 1 watt or 25 watts.

The **GX1400** series is capable of ITU-R M.493 DSC (Digital Selective Calling) Class D operation with a 66-channel internal GPS (GX1400GPS and GX1400GPS/E only). Class D operation allows continuous reception of Digital Selective Calling functions on channel 70 even while receiving calls on the voice channels. The **GX1400** series operates on all currently-allocated marine channels which are switchable for use with either International, USA, or Canadian* regulations. Emergency channel 16 can be immediately selected from any channel by pressing the red [**16/S**] key. NOAA weather channel can also be accessed immediately by pressing the [**WX**] soft key.

*(Depending on the transceiver version)

Other features of the GX1400 series include: a 66-channel internal GPS receiver (GX1400GPS and GX1400GPS/E only), scanning functions, priority scanning, dual watch, DSC position polling up to 6 vessels, high and low voltage warning, and GPS repeatability.

2 PACKING LIST

When the package containing the transceiver is first opened, please check for the following contents:

- Transceiver
- Mounting Bracket, two Mounting Knobs, and hardware
- Power Cord with 6 Amp fuse and holder
- DSC Warning Sticker (GX1400GPS and GX1400 only)
- Owner's Manual

3 OPTIONAL ACCESSORIES

- Dust Cover (white) **HC1100**
- Flush-Mount Bracket **MMB-84**
- External GPS Antenna with 16 ft (5 m) of Cable
(for GX1400GPS and GX1400GPS/E only) **SCU-38**
- External GPS Antenna* with 49 ft (15 m) of Cable
*(Built-in GPS Receiver. Refer to section 8.5.4 for connections.) **SCU-31**
- External Loud Speaker **MLS-300**

4 ONLINE WARRANTY REGISTRATION

Please visit **www.standardhorizon.com** - Owner's Corner to register the GX1400 Marine VHF.

NOTE: Visiting the STANDARD HORIZON website from time to time may be beneficial. When new products are released, information will appear on the website.

5 Safety Precautions (Be Sure to Read)

Be sure to read these important precautions, and use this product safely.

Yaesu is not liable for any failures or problems caused by the use or misuse of this product by the purchaser or any third party. Also, Yaesu is not liable for damages caused through the use of this product by the purchaser or any third party, except in cases where ordered to pay damages under the laws.

Types and meanings of the marks



DANGER

This mark indicates an imminently hazardous situation, which, if not avoided, could result in death or serious injury.



WARNING

This mark indicates a potentially hazardous situation, which, if not avoided, could result in death or serious injury.



CAUTION

This mark indicates a potentially hazardous situation, which, if not avoided, may result in minor or moderate injury or only property damage.

Types and meanings of symbols



These symbols signify prohibited actions, which must not be done to use this product safely. For example:  indicates that the product should not be disassembled.



These symbols signify required actions, which must be done to use this product safely. For example:  indicates that the power plug should be disconnected.



DANGER



Do not operate the device when flammable gas is generated.

Doing so may result in fire and explosion.



If thunder and lightning develop nearby when an external antenna is used, immediately turn this transceiver OFF, and disconnect the external antenna from it.

A fire, electrical shock, or damage may result.



Do not transmit with this device while carrying or using a medical appliance such as a cardiac pacemaker. When transmitting, use an external antenna and keep as far as possible away from the external antenna.

The radio wave emitted by the transmitter can cause the medical device to malfunction and result in injury or death.



Do not touch any liquid leaking from the liquid display with your bare hands.

There is a risk of chemical burns occurring when the liquid comes into contact with the skin or gets into the eyes. In this case, seek medical treatment immediately.



WARNING



Do not power this transceiver with a voltage other than the specified power supply voltage.
A fire, electric shock, or damage may result.



Do not make very long transmissions.
The main body of the transceiver may overheat, resulting in component failure or operator burns.



Do not disassemble or make any alteration to this product.
An injury, electric shock, or failure may result.



Never touch the antenna during transmission.
This may result in injury, electric shock and equipment failure.



Do not handle the power plug and connector etc. with wet hands. Also do not plug and unplug the power plug with wet hands.
This may result in injury, liquid leak, electric shock and equipment failure.



Disconnect the power cord and connection cables before incorporating items sold separately or replacing the fuse.
This may result in fire, electric shock and equipment failure.



When smoke or strange odors are emitted from the radio, turn off the power and disconnect the power cord from the socket.
This may result in fire, liquid leak, overheating, damage, ignition and equipment failure. Please contact our company customer support or the retail store where you purchased the device.



Keep the power plug pins and the surrounding areas clean at all time.
This may result in fire, liquid leak, overheating, breakage, ignition etc.



Never cut the fuse holder off of the DC power cord.
This may cause a short circuit and result in ignition and fire.



Use only the specified type fuses.
Use of an incorrect fuse may result in fire and equipment failure.



When connecting a DC power cord, be certain the positive and negative polarities are correct.
Reverse connection will result in equipment damage.



Do not use DC power cords other than the one enclosed or specified.
This may result in fire, electric shock and equipment malfunctions.



Do not bend, twist, pull, heat and modify the power cord and connection cables in an unreasonable manner.



This may cut or damage the cables and result in fire, electric shock and equipment failure.



Do not pull the cable when plugging and unplugging the power cord and connection cables.
Always hold the plug or connector when unplugging; if not, a fire, electric shock and equipment failure may result.



Do not use the device when the power cord and connection cables are damaged, or when the DC power connector cannot be plugged in tightly.



Contact Yaesu Amateur Customer Support or the retail store where this transceiver was purchased for assistance, as this may result in fire, electric shock and equipment failure.



Follow the instructions provided when installing items sold separately and replacing the fuse.
This may result in fire, electric shock and equipment failure.



Use only the provided or specified screws.
Using screws of a different size, may result in fire, electric shock and component damage.



CAUTION



Do not place the transceiver on an unsteady or sloping surface, or in a location with extreme vibration.
The transceiver may fall or drop, resulting in fire, injury and equipment damage.



Stay as far away from the antenna as possible during transmission.
Long-term exposure to electromagnetic radiation may have a negative effect on the human body.



Do not wipe the case using thinner and benzene etc.
Use only a soft, dry cloth to wipe stains from the case.



Keep this product out of the reach of children.
Injury to the child, or damage to the transceiver may result.



Do not put heavy objects on top of the power cord and connection cables.
This may damage the power cord and connection cables, resulting in fire and electric shock.



Do not use any products other than the specified options and accessories.
Failure or miss operation may result.



For safety reasons, switch off the power and pull out the DC power cord connected to the DC power connector when the device is not going to be used for a long period of time.
If not, this may result in fire and overheating.



Do not throw the transceiver, or subject it to strong impact forces.
Physical abuse may result in component damage and equipment failure.



Keep magnetic cards and videotapes away from the transceiver.
The data recorded on cash cards or videotapes may be erased.



Do not stand on top of the product, and do not place heavy objects on top or insert objects inside it.
If not, this may result in equipment failure.

6 GETTING STARTED

6.1 ABOUT VHF RADIO

The radio frequencies used in the VHF marine band lie between 156 and 158 MHz with some shore stations available between 161 and 163 MHz. The marine VHF band provides communications over distances that are essentially “line of sight” (VHF signals do not travel well through objects such as buildings, hills or trees). Actual transmission range depends much more on antenna type, gain and height than on the power output of the transmitter. On a fixed mount 25 W radio transmission expected distances can be greater than 25 km, for a portable 5 W radio transmission the expected distance can be greater than 8 km in “line of sight”.

6.2 SELECTING AN ANTENNA

Marine antennas are made to radiate signals equally in all horizontal directions, but not straight up. The objective of a marine antenna is to enhance the signal toward the horizon. The degree to which this is accomplished is called the antenna’s gain. It is measured in decibels (dB) and is one of the major factors in choosing an antenna. In terms of effective radiated power (ERP), antennas are rated on the basis of how much gain they have over a theoretical antenna with zero gain. A 1 m, 3 dB gain antenna represents twice as much gain over the imaginary antenna. Typically, a 1 m 3 dB gain stainless steel whip is used on a sailboat mast. The longer 2.5 m 6 dB fiberglass whip is primarily used on power boats that require the additional gain.

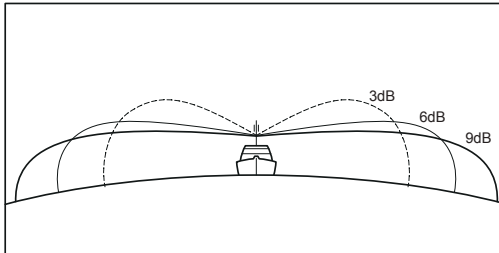

6.3 Coaxial Cable

VHF antennas are connected to the transceiver by means of a coaxial cable – a shielded transmission line. Coaxial cable is specified by its diameter and construction.

For runs less than 20 feet (6 m), RG-58/U (about 0.25" (6 mm) in diameter), is a good choice. For runs over 20 feet (6 m) but less than 50 feet (15 m), the larger RG-8X or RG-213/U should be used. For cable runs over 50 feet (15 m) RG-8X should be used. For installation of the connector onto the coaxial cable refer to the figure below.

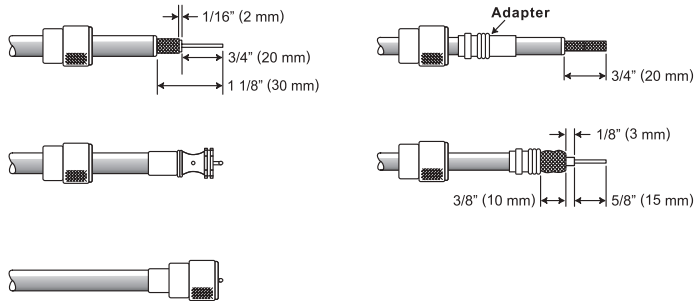

To get your coax cable through a fitting and into your boat's interior, you may have to cut off the end plug and reattach it later. You can do this if you follow the directions that are supplied with the connector. Be sure to make good soldered connections.

6.4 DISTRESS AND HAILING (CHANNEL 16)

Channel 16 is known as the Hail and Distress Channel. An emergency is defined as a threat to life or property. In such instances, be sure the transceiver is on and set to CHANNEL 16. Then use the following procedure:

1. Press the microphone push-to-talk switch and say "**Mayday, Mayday, Mayday**. This is _____, _____, _____" (your vessel's name).
2. Then repeat once: "**Mayday**, _____" (your vessel's name).
3. Now report your position in latitude/longitude, or by giving a true or magnetic bearing (state which) to a well-known landmark such as a navigation aid or geographic feature such as an island or harbour entry.
4. Explain the nature of your distress (sinking, collision, aground, fire, heart attack, life-threatening injury, etc.).
5. State the kind of assistance you desire (pumps, medical aid, etc.).
6. Report the number of persons aboard and condition of any injured.
7. Estimate the present seaworthiness and condition of your vessel.
8. Give your vessel's description: length, design (power or sail), color and other distinguishing marks. The total transmission should not exceed 1 minute.
9. End the message by saying "**OVER**." Release the microphone button and listen.
10. If there is no answer, repeat the above procedure. If there is still no response, try another channel.

NOTE

The transceiver has DSC Distress calling, that can transmit a distress call digitally to all ships with compatible DSC radios. Refer to section "**10 DIGITAL SELECTIVE CALLING (DSC)**".

6.5 CALLING ANOTHER VESSEL (CHANNEL 16 OR 9)

Channel 16 may be used for initial contact (hailing) with another vessel.

However, its most important use is for emergency messages. This channel must be monitored at all times except when actually using another channel.

It is monitored by the European, U.S. and Canadian Coast Guards and by other vessels. Use of channel 16 for hailing must be limited to initial contact only. Calling should not exceed 30 seconds, but may be repeated 3 times at 2-minute intervals. In areas of heavy radio traffic, congestion on channel 16 resulting from its use as a hailing channel can be reduced significantly in U.S. waters by using channel 9 as the initial contact (hailing) channel for non-emergency communications. Here, also, calling time should not exceed 30 seconds but may be repeated 3 times at 2-minute intervals.

Prior to making contact with another vessel, refer to the channel charts in this manual, and select an appropriate channel for communications after initial contact. For example, Channels 68 and 69 are some of the channels available to non-commercial (recreational) boaters. Monitor your desired channel in advance to make sure you will not be interrupting other traffic, and then go back to either channel 16 or 9 for your initial contact.

When the hailing channel (16 or 9) is clear, state the name of the other vessel you wish to call and then “this is” followed by the name of your vessel and your Station License (Call Sign). When the other vessel returns your call, immediately request another channel by saying “go to,” the number of the other channel, and “over.” Then switch to the new channel. When the new channel is not busy, call the other vessel. After a transmission, say “**over**,” and release the microphone’s push-to-talk (PTT) switch. When all communication with the other vessel is completed, end the last transmission by stating your Call Sign and the word “**out**.” Note that it is not necessary to state your Call Sign with each transmission, only at the beginning and end of the contact.

Remember to return to Channel 16 when not using another channel. Some radios automatically monitor Channel 16 even when set to other channels or when scanning.

6.6 Accuracy of COG*

The error in the COG (the path of the antenna position over ground) due to the actual ship’s speed over ground shall not exceed the following values:

Speed range (knots)	Accuracy of COG output to user
0 to ≤1 knot	Unreliable or not available
>1 to ≤17 knots	±3°
>17 knots	±1°

7 CONTROLS AND INDICATORS

7.1 FRONT PANEL

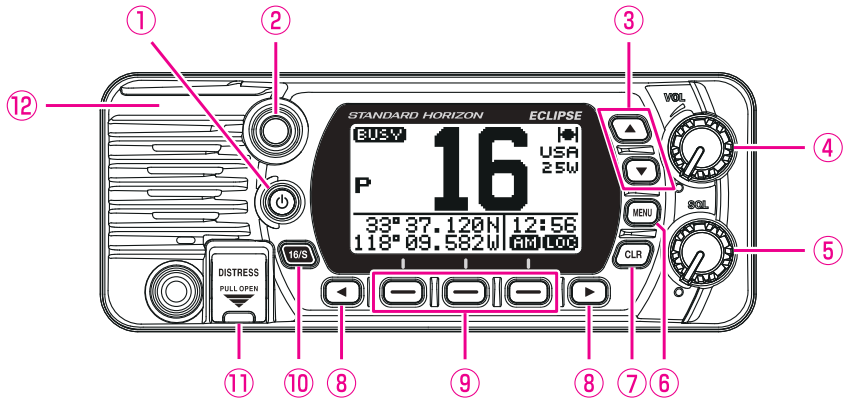

- ① **⏻ (Power) key**
Press and hold to toggle the radio on or off. When the power is turned on, the transceiver is set to the last selected channel.
- ② **BUSY Indicator Lamp**
This indicator glows green when the squelch opens.
- ③ **▲&▼ key**
These keys are used to change the operating channel. The Up/Down keys on the microphone can also be used to change the operating channel. Press the key momentarily, the channel increases/decreases one step. Holding the key, the channel increases/decreases continuously.
SECONDARY USE
While the MENU screen is displayed, press the key to slide the on-screen MENU upward/downward.
- ④ **VOL knob (Volume control)**
Adjusts the audio volume level.
Clockwise rotation of this knob increases the internal and speaker microphone volume.
- ⑤ **SQL knob (Squelch control)**
Adjusting this control clockwise, sets the point at which random noise on the channel does not activate the audio circuits but a received signal does. This point is called the squelch threshold. Further adjustment of the squelch control will degrade reception of wanted transmissions.

- ⑥ **MENU key**
Press to access MENU. For details, refer to section “**9.5 BASIC OPERATION OF THE SETUP MENU**”.
- ⑦ **CLR key**
Press this key to cancel a MENU selection or functions.
- ⑨ **Soft keys**
Press these keys to display the soft keys.
The 3 programmable soft keys can be customized by the Setup MENU mode described in section “**11.5.4 Soft Keys**”.
- ⑧ **◀ & ▶ key**
Press these keys to switch the function of soft keys.
SECONDARY USE
While the MENU screen is displayed, press the key to slide the on-screen MENU to the right/left side.
- ⑩ **16/S key**
Pressing this key immediately recalls channel 16 from any channel location. Holding down this key selects the SUB channel (The default setting is channel 9). Pressing this key again reverts to the previous selected working channel.
- ⑪ **DISTRESS key**
Used to send a DSC Distress Call. To send the distress call, refer to section “**10.2.1 Transmitting a DSC Distress Alert**”.
- ⑫ **GPS Antenna (GX1400GPS and GX1400GPS/E only)**
Built in GPS antenna is in here.

7.2 MICROPHONE

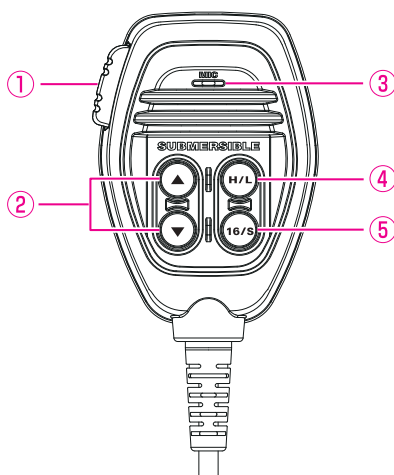

① **PTT (Push-To-Talk) switch**

When in radio mode and the PTT switch is pressed, the transmitter is enabled for voice communications to another vessel.

② **▲ & ▼ key**

These keys on the microphone are used to select channels and to choose MENU items.

③ **Microphone**

The internal microphone transmits your voice reducing background noise using Clear Voice Noise Reduction Technology.

When transmitting, position the microphone about 1/2 to 1 inch (1.2 ~ 2.5 cm) away from your mouth. Speak slowly and clearly into the microphone.

④ **H/L key**

Press this key to toggle between 25 W (High) and 1 W (Low) power. When the TX output power is set to “Low” while the transceiver is on channel 13 or 67, the output power will temporarily switch from “Low” to “High” power until the PTT switch of the microphone is released. This key is not available on transmit inhibited and low power only channels.

⑤ **16/S key**

Pressing this key immediately selects channel 16 from any channel location. Holding down this key selects the SUB channel (The default setting is channel 9). Pressing this key again reverts to the previous selected working channel.

7.3 REAR PANEL

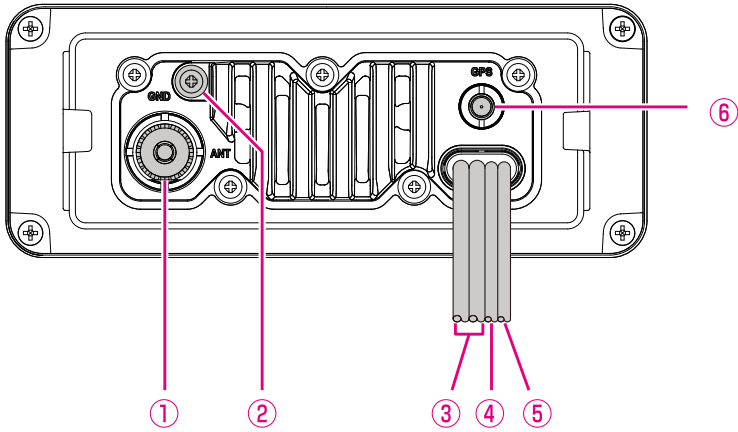

- ① **VHF ANT jack** (VHF antenna jack)
Connects an antenna to the transceiver. Use a marine VHF antenna with an impedance of 50 ohms.
- ② **GND Terminal** (Ground Terminal)
Connects the transceiver to ships ground, for safe and optimum performance.
Use the screw supplied with the transceiver only.
- ③ **DC Input Cable**
Connects the transceiver to a DC power supply capable of delivering 11 to 16 VDC.
- ④ **Accessory Connection Cable** (Green, Brown, Yellow & White)
Connects the transceiver to a GPS chart plotter. Refer to section “8.5.2 Accessory Cables”.
- ⑤ **EXTERNAL Speaker Connection Cable** (White & Shield)
Connects the transceiver to an optional external speaker. Refer to section “3 OPTIONAL ACCESSORIES” for a list of optional STANDARD HORIZON Speakers.
White: External Speaker (+)
Shield: External Speaker (-)
- ⑥ **GPS ANT Connector** (GX1400GPS and GX1400GPS/E only)
Connects the optional SCU-38 External GPS Antenna.

8 INSTALLATION

8.1 SAFETY / WARNING INFORMATION

This radio is restricted to occupational use, work related operations only where the radio operator must have the knowledge to control the exposure conditions of its passengers and bystanders by maintaining the minimum separation distance of 4.6 feet (1.40 m) (FCC) or 5.7 feet (1.74 m) (IC). Failure to observe these restrictions will result in exceeding the FCC/IC RF exposure limits.

Antenna Installation:

The antenna must be located at least 4.6 feet (1.40 m) (FCC) or 5.7 feet (1.74 m) (IC) away from passengers in order to comply with the FCC/IC RF exposure requirements.

8.2 LOCATION

The radio can be mounted at any angle. Choose a mounting location that:

- complies with the compass safe distances shown in the table below to prevent interference to a magnetic compass

Transceiver Unit	1.0 m
Handset	0.5 m

- provides accessibility to the front panel controls
- allows connection to a power source and antennas
- has nearby space for installation of a microphone hanger
- is at least 4.6 feet (1.40 m) (FCC) or 5.7 feet (1.74 m) (IC) away from the radio's antenna
- the signal from the GPS satellite can receive sufficiently

NOTE: To insure the radio does not affect the compass or radios performance is not affected by the antenna location, temporarily connect the radio in the desired location and:

- a. Examine the compass to see if the radio causes any deviation
- b. Connect the antenna and key the radio. Check to ensure the radio is operating correctly by requesting a radio check.

8.3 MOUNTING THE RADIO

8.3.1 Supplied Mounting Bracket

The supplied mounting bracket allows overhead or desktop mounting.

Use a 13/64" (5.2 mm) bit to drill the holes to a surface which is more 0.4 inch (10 mm) thick and can support more than 3.3 lbs (1.5 kg) and secure the bracket with the supplied screws, spring washers, flat washers, and nuts.

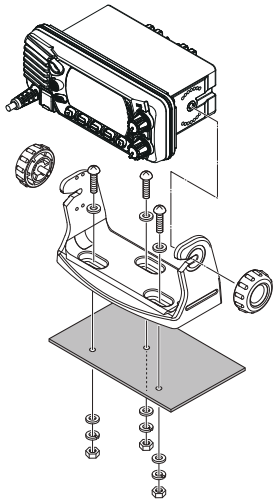

Desktop Mounting

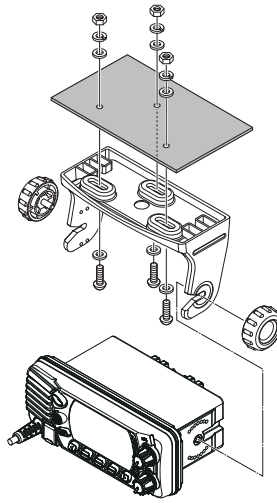

Overhead Mounting

8.3.2 Optional MMB-84 Flush Mount Bracket

A GPS receiver and antenna is located in the front panel of the **GX1400GPS** and **GX1400GPS/E**. In many cases the radio may be flush mounted, however before cutting holes to flush mount the radio it is recommended to temporarily connect the radio to power and turn on in the location where it will be flush mounted to confirm it is able to receive a GPS location on it's display. If the radio is not able to receive a location, a GPS Chart plotter with NMEA 0183 output or the optional **SCU-38** External GPS Antenna may be needed to receive GPS satellite signals.

1. Use the template (page 93) to mark the location where the rectangular hole is to be cut. Confirm the space behind the dash or panel is deep enough to accommodate the transceiver (at least 4.72" (120 mm) deep).
There should be at least 1/2 inch (1.3 cm) between the transceiver's heat sink and any wiring, cables or structures.
2. Cut out the rectangular hole and insert the transceiver.
3. Fasten the brackets to the sides of the transceiver with the lock washer nut combination, so that the mounting screw base faces the mounting surface.
4. Turn the adjusting screw to adjust the tension so that the transceiver is tight against the mounting surface.

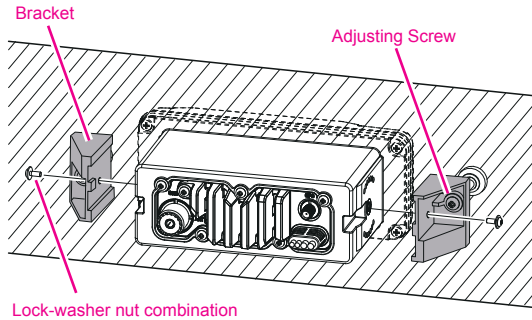

8.4 ELECTRICAL CONNECTIONS

CAUTION

Reverse polarity connections will damage the radio!

Connect the power cord and antenna to the radio. Antenna and Power Supply connections are as follows:

1. Mount the antenna at least 3.28 feet (1 m) away from the radio. At the rear of the radio, connect the antenna cable. The antenna cable must have a PL259 connector attached. RG-8/U coaxial cable must be used if the antenna is 25 feet (7.6 m) or more from the radio. RG58 cable can be used for distances less than 25 feet (7.6 m).
2. Connect the red power wire to a 13.8 VDC $\pm 20\%$ power source. Connect the black power wire to a negative ground.
3. If an optional remote extension speaker is to be used, refer to next section for connections.
4. It is advisable to have a Certified Marine Technician check the power output and the standing wave ratio of the antenna after installation.

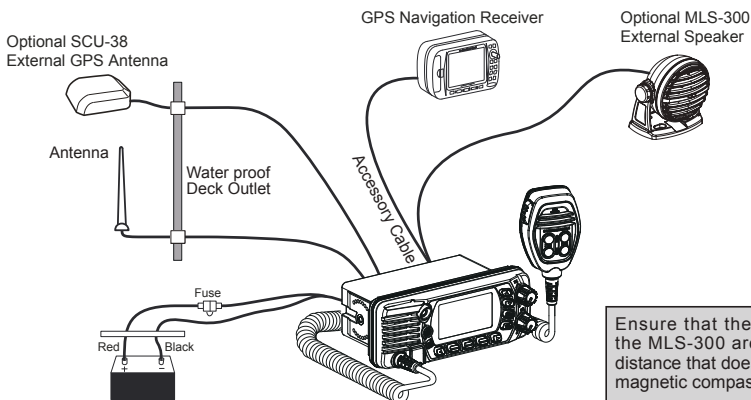

Ensure that the SCU-38 and the MLS-300 are located at a distance that does not affect the magnetic compass.

Fuse Replacement

To take out the fuse from the fuse holder, hold both ends of the fuse holder and pull the fuse holder apart, do not bend the fuse holder. When you replace the fuse, please confirm that the fuse is tightly fixed on the metal contact located inside the fuse Holder. If the metal contact holding the fuse is loose, the fuse holder may heat up.

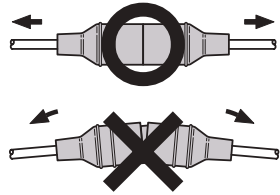

8.5 CONNECTION OF EXTERNAL DEVICES TO THE RADIO

8.5.1 Connecting the NMEA 0183/NMEA 0183-HS to the Radio

External GPS Device Connections (NMEA 0183 4800 baud or NMEA 0183-HS 38400 baud)

The GX1400 series can select the NMEA baud rate between “4800 bps” and “38400 bps”. Refer to section “**11.4.7 Output Sentences**” for selection.

NMEA Input (GPS Information)

- GX1400 can read NMEA 0183 version 2.0 or higher, and NMEA 0183-HS version 1.01 or higher.
- The NMEA 0183 input sentences are GLL, GGA, RMC, GNS, GSA, and GSV (RMC sentence is recommended).
- If 4800 baud (default) is selected:
The Yellow and Green wires of input are at 4800 baud.
- If 38400 baud is selected:
The Yellow and Green wires of input are at 38400 baud.

NMEA Output (DSC and GPS information)

- The NMEA 0183 output sentences are DSC and DSE.
- If 4800 baud (default) is selected:
The White and Brown wires output DSC and DSE sentences.
- If 38400 baud is selected:
The White and Brown wires of output are at 38400 baud and includes DSC (DSC, DSE) sentences.
- GSA, GSV, GLL, GGA, and RMC sentences can be output in the GX1400 series by setting through the GPS setup menu (refer to section “**11.4.7 Output Sentences**”).

For further information on interfacing/setting up your GPS, please contact the manufacturer of the GPS receiver externally connected.

If you have further questions, please contact your Dealer.

8.5.2 Accessory Cables

The image and table below show the wires of the transceiver and the connections to optional devices such as an external GPS antenna and a GPS chart plotter.

CAUTION

Care must be taken not to touch any of the NMEA wires to positive 12 VDC or the radio may be damaged.

When connecting the Chart Plotter, External GPS receiver, or External Speaker strip off about 1 inch (2.5 cm) of the specified wire's insulation, then splice the ends together.

The GX1400 series uses NMEA 0183/-HS protocol to share coordinates and DSC information to and from a GPS chart plotter.

Wire Color/Description	Connection Examples
Yellow: NMEA GPS Input (+)	NMEA (+) output of GPS
Green: NMEA GPS Input (-)*1	NMEA (-) output or common ground of GPS
White: NMEA DSC Output (+)	NMEA (+) input of GPS
Brown: NMEA DSC Output (-)*1	NMEA (-) input or common ground of GPS

NOTE: *1: Some GPS chart plotters have a single wire for NMEA signal ground. In such a case connect the NMEA input (-) to the GPS chart plotter's single NMEA signal ground wire, and leave the NMEA output (-) open.

In case the assignment of power supply and ground of a GPS chart plotter to be used is different from that of the radio, connect the signal ground wire of the GPS chart plotter to the ground terminal (GND) on the rear panel of the radio.

8.5.3 Connection to External GPS or Chart Plotter

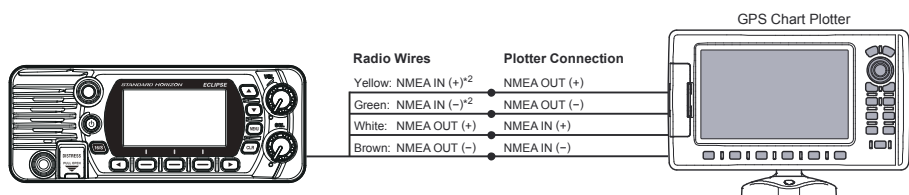

NOTE: *2: To inputs the GPS coordinates from the external GPS device to the GX1400, the NMEA GPS input (+) (yellow) and the NMEA GPS input (-) (green) wire may be connected to the NMEA output of the external GPS antenna or GPS chart plotter.

To connect with external device at 38400 baud

To connect with external device at 38400 baud, the GX1400 series may be setup to receive GPS coordinates, send DSC signal at 38400 baud. Refer to section "18.9 NMEA 0183 IN/OUT" for details.

8.5.4 GPS Input - optional SCU-31 External GPS Antenna

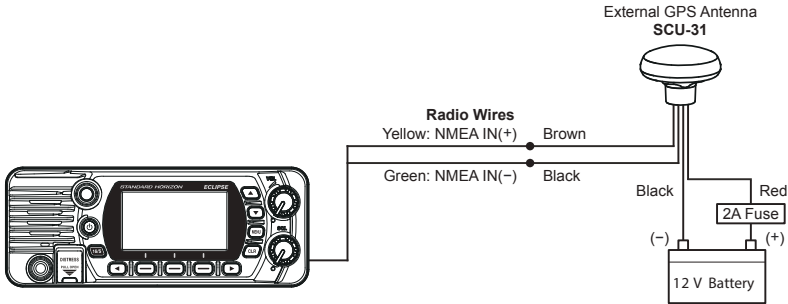

The **SCU-31** External GPS antenna (Built-in GPS receiver) is supplied with 49 feet (15 m) of cable and a connector. To connect the **SCU-31** to the transceiver, cut off the 6 pins antenna connector, strip the white insulation to expose the Red, Black and Brown wires and connect as shown in the diagram. All other wires are not used and may be cut off. The 2 amp fuse is not included.

8.5.5 Connection to External Speaker

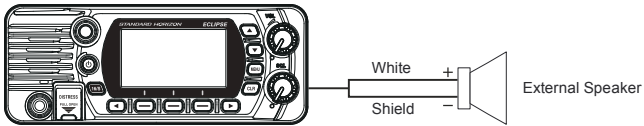

Wire Color/Description	Connection Examples
White: External Speaker (+)	Positive wire of external 4 Ohm External speaker
Shield: External Speaker (-)	Negative wire of external 4 Ohm External speaker

8.5.6 Connecting the SCU-38 External GPS Antenna to the Radio (GX1400GPS and GX1400GPS/E only)

Installed the SCU-38 in a location where the structure does not interfere with the signal, it will have better performance than the internal GPS antenna.

Connect the **SCU-38** cable to the **GPS ANT** connector (Coaxial connector) on the rear panel, then tighten the cable nut (see illustration at the right).

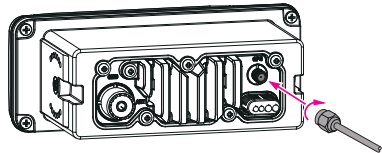

NOTE: The **SCU-38** External GPS Antenna is always used preferentially than the internal GPS antenna.

8.6 INITIAL SETUP REQUIRED WHEN TURNING ON THE POWER FOR THE FIRST TIME

8.6.1 Maritime Mobile Service Identity (MMSI)

What is an MMSI?

An MMSI is a nine digit number used on marine transceivers capable of using Digital Selective Calling (DSC) signal transmission. This number is used like a telephone number to selectively call other vessels.

THIS NUMBER MUST BE PROGRAMMED INTO THE RADIO TO OPERATE DSC FUNCTIONS.

How can I obtain an MMSI assignment?

Please contact the Radio Licensing Authority for your country for information on how to obtain an MMSI number.

WARNING

The MMSI can be inputted only once, please be careful not to input the incorrect MMSI number. If the MMSI number need to be reset. Please contact Standard Horizon to obtain the required reset code. Refer to the section “**11.5.6 Reset the USER MMSI and ATIS CODE**”.

Programming the MMSI

1. Press the [MENU] key to display “MENU”.
2. Press the ▲/▼/◀/▶ key to select “MMSI/POS INFO”, then press the [SELECT] soft key. (To cancel, press the [BACK] soft key.)
3. The “MMSI INPUT” screen is displayed which has not yet set the MMSI.
In the case of the transceiver which has completed the MMSI setting, you can only check the MMSI number on this screen.
4. Press the [▲] or [▼] key to select the first number of your MMSI, then press the [SELECT] soft key to step to the next number.
5. Repeat step 4 to set your MMSI number (9 digits).
If a mistake was made entering in the MMSI number, press the [◀] or [▶] key until the wrong character is selected, then perform step 4.

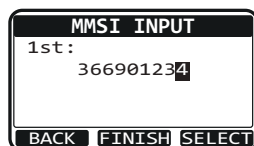
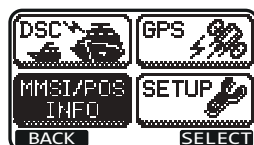

6. When finished programming the MMSI number, press the **[FINISH]** soft key. The radio will ask you to input the MMSI number again. Perform steps 4 through 6 above.
7. After the second number has been input, press the **[FINISH]** soft key to store the MMSI.
8. Press the **[OK]** soft key to return to radio operation.

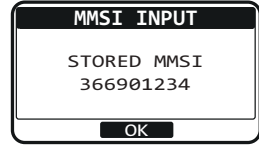
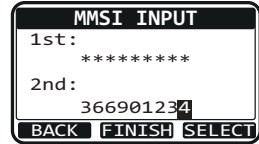

NOTE

To view your MMSI after programming to ensure it is correct, perform steps 1 to 2. Look that the MMSI number shown on the display is correct.

8.7 CHECKING GPS CONNECTIONS (GPS STATUS DISPLAY)

When the transceiver receives the GPS signal from the internal GPS receiver or the NMEA 0183, an icon will appear on the display as shown below.

Receive GPS signal from	GX1400GPS GX1400GPS/E	GX1400
Internal GPS Receiver	📶	—
NMEA 0183	I/O	📶

If there is a problem with the NMEA 0183 connection between the radio and the GPS, the GPS icon will blink continuously until the connection is corrected.

After connections have been made between the transceiver and the GPS, a small satellite icon will appear on the top right corner of the display, and displays your current location (Latitude/Longitude) on the display.

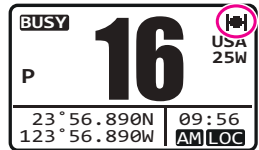

NOTE

- The transceiver preferentially uses the GPS position information from the external input (NMEA 0183) rather than the internal GPS receiver. To check the status of Internal GPS receiver, do not input signals from the external input.
- If a GPS with NMEA 0183 output is not connected to the radio, the transceiver will beep 10 minutes after the radio is turned on. After that the transceiver will beep every 4 hours alerting to connect a GPS.

The transceiver has a GPS status display which shows the satellites currently being received, along with a graphical (bar-graph) representation of the relative signal strengths from each of the satellites.

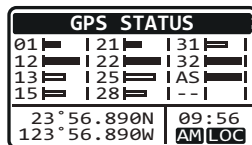

(GPS STATUS DISPLAY)

NOTE

When the GPS reception is limited, such as the flush mounting of the **GX1400GPS** and **GX1400GPS/E**, it is recommended to connect optional External GPS Antenna **SCU-38** to GPS ANT connector on the rear panel.

1. Press hold the [MENU] key to display the "MENU".
2. Press the ▲/▼/◀/▶ key to select "GPS", then press the [SELECT] soft key.
The "GPS STATUS" screen will appear.
3. Press the [CLR] key to return to radio operation.



NOTE

For the transceiver to properly show the GPS status page when an external GPS receiver or a chart plotter is connected, the external device must be setup to output GSA and GSV NMEA 0183 sentences.

8.8 GPS CONFIGURATION

8.8.1 Changing the GPS Time

The transceiver shows GPS satellite time or UTC (Universal Time Coordinated) time in factory default. A time offset is needed to show the local time in your area. The time offset must be changed in order for the radio to display the current time in your area.

1. Press the **[MENU]** key to display the “**MENU**”.
2. Press the **▲/▼/◀/▶** key to select “**SETUP**”, then press the **[SELECT]** soft key.
3. Press the **[▲]** or **[▼]** key to select “**GPS SETUP**”, then press the **[SELECT]** soft key.
4. Press the **[▲]** or **[▼]** key to select “**TIME OFFSET**”, then press the **[SELECT]** soft key.
5. Press the **[▲]** or **[▼]** key to select time offset of your location. If “**00:00**” is assigned, the time is the same as UTC.
6. Press the **[ENTER]** soft key to store the time offset.
7. Press the **[CLR]** soft key to return to radio operation.

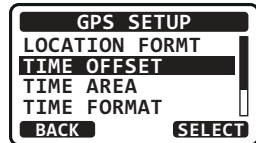
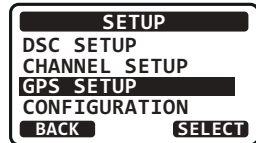

8.8.2 Changing the Time Area

This menu selection allows the transceiver to show UTC time or local time with the offset.

1. Press the **[MENU]** key to display the “**MENU**”.
2. Press the **▲/▼/◀/▶** key to select “**SETUP**”, then press the **[SELECT]** soft key.
3. Press the **[▲]** or **[▼]** key to select “**GPS SETUP**”, then press the **[SELECT]** soft key.

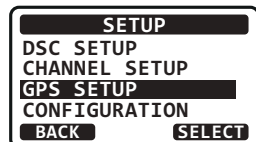

- Press the [▲] or [▼] key to select “**TIME AREA**”, then press the [SELECT] soft key.
- Press the [▲] or [▼] key to select “**UTC**” or “**LOCAL**”.
- Press the [ENTER] soft key to store the selected setting.
- Press the [CLR] soft key to return to radio operation.

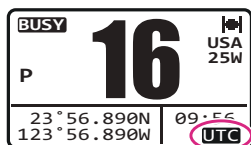
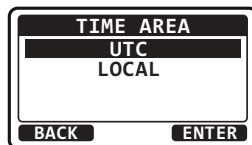
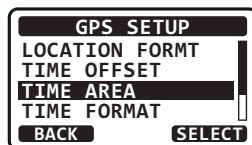

("UTC" mode)

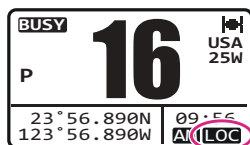

("LOCAL" mode)

8.8.3 Changing the Time Format

This MENU item allows you to choose to show time in 12-hour or 24-hour format.

- Press the [MENU] key to display the “**MENU**”.
- Press the ▲/▼/◀/▶ key to select “**SETUP**”, then press the [SELECT] soft key.
- Press the [▲] or [▼] key to select “**GPS SETUP**”, then press the [SELECT] soft key.
- Press the [▲] or [▼] key to select “**TIME FORMAT**”, then press the [SELECT] soft key.
- Press the [▲] or [▼] key to select “**12 HOURS**” or “**24 HOURS**”.
- Press the [ENTER] soft key to store the selected setting.
- Press the [CLR] soft key to exit the “**MENU**”.

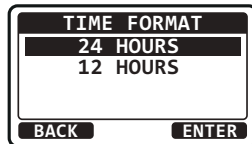
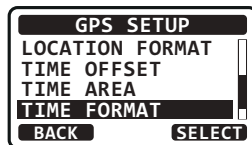
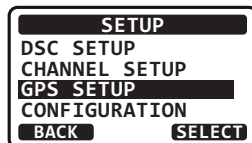



9 BASIC OPERATION

9.1 TURNING ON AND OFF THE TRANSCEIVER

1. After the transceiver has been installed, ensure that the power supply and antenna are properly connected.
2. Press and hold the  key to turn the radio **ON**.

9.2 RECEPTION

1. Turn the **SQL** knob fully counterclockwise. This state is known as “squelch off”.
2. Turn the **VOL** knob until noise or audio from the speaker is at a comfortable level.
3. Turn the **SQL** knob clockwise until the random noise disappears. This state is known as the “squelch threshold”.
4. Press the [] or [] key to select the desired channel. Refer to the “**13 CHANNEL ASSIGNMENTS**” (page 81) for available channels.
5. When a signal is received, adjust the volume to the desired listening level. The **BUSY** Indicator Lamp glows green, and the **BUSY** icon on the display indicates that communications are being received.

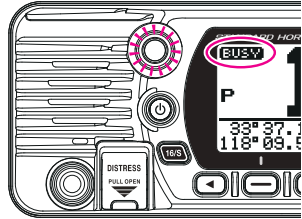

9.3 TRANSMISSION

1. Perform steps 1 through 6 of RECEPTION.
2. Before transmitting, monitor the channel to ensure it is clear.
THIS IS AN FCC REQUIREMENT!
3. Press and hold the **PTT** (push-to-talk) switch of the microphone. The “**TX**” indicator appears on the LCD.
4. Speak slowly and clearly into the microphone.
5. When the transmission is finished, release the **PTT** switch.

NOTE

Position your mouth about 1 inch (2.5 cm) away from the microphone hole and speak in a normal voice.

9.3.1 Transmit Power

The TX output power of the **GX1400** series is set to high level (25 W) in factory default, and the “HI” indicator is displayed on the top part of the screen.

To switch the TX output power:

1. Press the [H/L] key on the front panel or the microphone to switch between HI (25 W) or LO (1 W) output power.

NOTE: When the TX output power is set to “Low” while the transceiver is on channel 13 or 67 (USA Channel group only), the output power will temporarily switch from “Low” to “High” power until the **PTT** switch of the microphone is released. This soft key is not function on transmit inhibited and low power only channels.

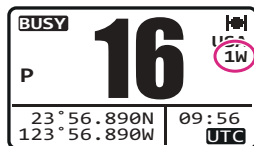
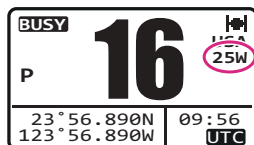

9.4 TRANSMIT TIME-OUT TIMER (TOT)

When the **PTT** switch on the microphone is held down, transmit time is limited to 5 minutes. This limits unintentional transmissions due to a stuck microphone. About 10 seconds before automatic transmitter shutdown, a warning beep will be heard from the speaker(s). The transceiver will automatically go to receive mode, even if the **PTT** switch is continually held down. Before transmitting again, the **PTT** switch must first be released and then pressed again.

NOTE

When a transmission was shut down by the TOT, the **GX1400** can not transmit afterwards for 10 seconds.

9.5 BASIC OPERATION OF THE SETUP MENU

Using the setup menu, the various functions of the GX1400 series can be customized to match the method of use. You can select the items that you would like to adjust from the respective lists and enter or select the appropriate settings for the intended various operation.

1. Press the [MENU] key on the operation mode screen.
2. Press the [▲] or [▼] key to select the “**SETUP**”, then press the [SELECT] soft key.
3. Press the [▲] or [▼] key to select the function item, then press the [SELECT] soft key.

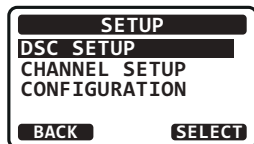

- Press the [▲] or [▼] key to select the setting item, then press the [SELECT] soft key.

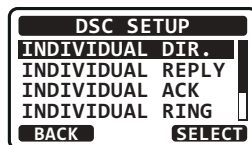

- Press the [▲] or [▼] key to select the desired setting.
- Press the [ENTER] soft key to store the selected setting.
- Press the [CLR] key to return to radio operation. (The display can also be returned to the previous screen by pressing the [BACK] soft key.)

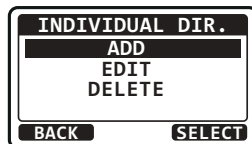

The same operation process as the above is written as follows in this operation manual.

[MENU] → "SETUP" → "CONFIGURATION" → "DSC SETUP"

9.6 SIMPLEX/DUPLEX CHANNEL USE

Refer to the "13 CHANNEL ASSIGNMENTS" (page 81) for instructions on use of simplex and duplex channels.

NOTE

All channels are factory-programmed in accordance with International, Industry Canada (Canada), and FCC (USA) regulations. Mode of operation cannot be altered from simplex to duplex or vice-versa.

9.7 CHANNEL GROUP

Set the Channel Group according to the region:

- [MENU] → "SETUP" → "CHANNEL SETUP" → "CHANNEL GROUP"

- Press the [▲] or [▼] key to select desired channel group "USA", "INTL", or "CAN"*1.

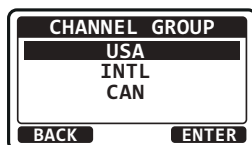

*1: In the European version, when setting the region, the selected European Channel Group will be displayed instead of "CAN". For details, refer to the note on the setting the region on the separate yellow insert sheet.

- Press the [ENTER] soft key to store the selected setting.
- Press the [CLR] key to return to radio operation.

Refer to the "13 CHANNEL ASSIGNMENTS" (page 81) for allocated channels in each mode.

9.8 NOAA WEATHER CHANNELS (in USA and Canada only)

1. To receive a NOAA weather channel, press one of the soft keys, then press the WX soft key from any channel. The transceiver will go to the last selected weather channel and the “WX” icon appears on the display.
2. Press the [▲] or [▼] keys to select a different NOAA weather channel.
3. To exit from the NOAA weather channels, press one of the soft keys, then press the [CH] soft key. The transceiver returns to the channel it was on prior to a weather channel and the “WX” icon disappears from the display.



9.8.1 NOAA Weather Alert (USA version only)

In the event of extreme weather disturbances, such as storms and hurricanes, the NOAA (National Oceanic and Atmospheric Administration) sends a weather alert accompanied by a 1050 Hz tone and transmits a subsequent weather report on one of the NOAA weather channels.

The GX1400GPS and GX1400 can receive weather alerts when monitoring a weather channel and, on the last selected weather channel during scanning modes or while on another working channel.

To enable the weather alert function, refer to section “11.2.2 Weather Alert (USA version only)”.

When an alert is received on a NOAA weather channel, scanning will stop and the transceiver will emit a loud beep to alert the user of a NOAA broadcast. Press any key to stop the alert. After stopping the beep sound, the weather alert reception confirmation screen will appear. Press [OK] to display a confirmation screen. The confirmation screen will ask you whether to move to the weather channel or return in the marine channel. Press [YES] to switch to the weather channel, and press [NO] to return to the marine channel.



NOTE

If no key is pressed the alert will sound for 5 minutes and then the weather report will be received.

9.8.2 NOAA Weather Alert Testing

NOAA tests the alert system every Wednesday between 11AM and 1PM. To test the NOAA weather feature, on Wednesday between 11AM and 1PM, setup as in section “11.2.2 Weather Alert (USA version only)” and confirm the alert is heard.

9.9 MULTI WATCH (TO PRIORITY CHANNEL)

Multi watch is used to scan two or three channels for communications.

- In Dual Watch, a normal VHF channel and the priority channel are scanned alternately.
- In Triple Watch, a normal VHF channel, the priority channel, and the sub channel are scanned alternately.

When a signal is received on the normal channel the radio briefly switches between the normal channel and the priority channel to look for a transmission. If the radio receives communications on the priority channel the radio stops and listens to priority channel until communication ends and then starts dual or triple watch scan again.

9.9.1 Setting up the Multi Watch Operation

1. [MENU] → "SETUP" → "CHANNEL SETUP" → "MULTI WATCH"

2. Press the [▲] or [▼] key to select "DUAL" or "TRIPLE."

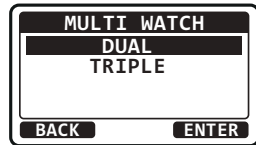

3. Press the [ENTER] soft key to store the selected setting.
4. Press the [CLR] key to return to radio operation.

9.9.2 Starting the Dual Watch

1. Adjust the **SQL** knob until the background noise disappears.
2. Press the [▲] or [▼] key to select a channel you wish to dual watch to the priority channel.
3. Press one of the soft keys.
4. Press [◀] or [▶] key repeatedly until the [DUAL WATCH] soft key is displayed at the bottom of the screen, press the [DW] soft key.



"DW - ##" (## indicates the priority channel number you have selected) appears on the LCD. The radio will scan between the priority channel and the channel that was selected in step 2.

If a transmission is received on the channel selected in step 2, the GX1400 series will dual watch to the priority channel.

5. To stop dual watch, press one of the soft keys, then press the [DW] soft key again.

When selecting "TRIPLE" in the SETUP MENU, [TW] will be displayed as the soft key instead of [DW].

NOTE

The priority channel or the sub channel may be changed from CH16 (default) or CH9 (default) to another channel. Refer to section “11.2.7 Priority Channel” or “11.2.8 Sub Channel”.

9.10 SCANNING

The **GX1400** series will automatically scan channels programmed into the preset channel memory and also the scan channel memory, and the last selected weather channel.

When an incoming signal is detected on one of the channels during scan, the radio will pause on that channel, allowing you to listen to the incoming transmission. The radio will automatically start scanning again after the transmission stops.

9.10.1 Selecting the Scan Type

1. [MENU] → “SETUP” → “CHANNEL SETUP” → “SCAN TYPE”

2. Press the [▲] or [▼] key to select “PRIORITY SCAN” or “MEMORY SCAN”.

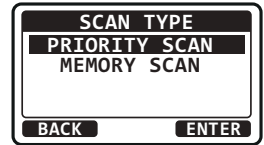

3. Press the [ENTER] soft key to store the selected setting.

4. Press the [CLR] key to return to radio operation.

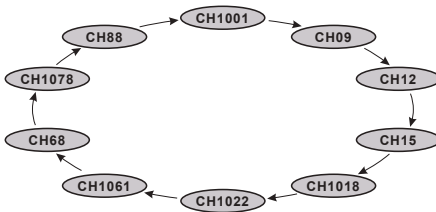

MEMORY SCAN (M-SCAN)

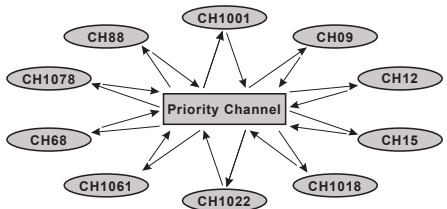

PRIORITY SCAN (P-SCAN)

9.10.2 Programming Scan Memory

1. [MENU] → "SETUP" → "CHANNEL SETUP" → "SCAN MEMORY"

2. Press the [▲] or [▼] key to select a desired channel to be scanned, then press the [MEM] soft key. The "MEM" icon appears on the display, which indicates the channel has been selected to the scan channel.
3. Repeat step 2 for all the desired channels to be scanned.
4. To delete a channel from the list, select the channel then press the [MEM] soft key again. The "MEM" icon disappears from the display.
5. Press the [CLR] key to return to radio operation.

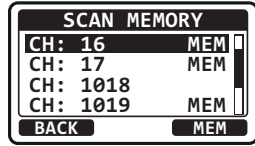

9.10.3 Memory Scanning (M-SCAN)

1. Set the scan type to "MEMORY SCAN" in the SETUP menu (refer to "9.10.1 Selecting the Scan Type").
2. Adjust the **SQL** knob until background noise disappears.
3. Press one of the soft keys.
4. Press the [◀] or [▶] key repeatedly, until the [P-SET] soft key display, then press the [SCAN] soft key. The "M-SCN" icon appears on the LCD. Scanning will proceed from the lowest to the highest programmed channel number and will stop on a channel when a transmission is received.
5. The channel number will blink during reception.
6. To stop scanning, press the [16/S] key or press one of the soft keys, then press the [SCAN] soft key.



9.10.4 Priority Scanning (P-SCAN)

1. Set the scan type to “**PRIORITY SCAN**” in the SETUP menu (refer to “**9.10.1 Selecting the Scan Type**”).
2. Adjust the **SQL** knob until background noise disappears.
3. Press one of the soft keys, until the [**SCAN**] soft key display, then press the [**SCAN**] soft key. “**P-SCN**” appears on the LCD. Scanning will proceed between the memorized channels and the priority channel. The priority channel will be scanned after each programmed channel.
4. Scanning will stop on a channel when a transmission is received. The channel number will blink during reception.
5. To stop scanning, press the [**16/S**] key or press one of the soft keys, then press the [**SCAN**] soft key.

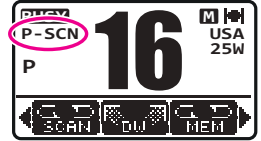

NOTE

In the default setting, Channel 16 is set as the priority channel. You may change the priority channel to the desired channel from Channel 16 on the SETUP menu. Refer to section “**11.2.7 Priority Channel**”.

9.11 PRESET CHANNELS: INSTANT ACCESS

10 preset channels can be programmed for instant access. Pressing the [**P-SET**] soft key activates the preset channel bank. If the [**P-SET**] soft key is pressed and no channels have been assigned, an alert beep will be emitted from the speaker.

For details about the assignment of the P-SET and other soft keys, see “**11.5.4 Soft Keys**”.

9.11.1 Programming

1. Press the [**▲**] or [**▼**] key to select the channel to be programmed.
2. Press one of the soft keys.
3. Press the [**◀**] or [**▶**] key repeatedly, until the [**P-SET**] soft key display, then press and hold the [**P-SET**] soft key until the “**P-SET**” icon and channel number are blinking.

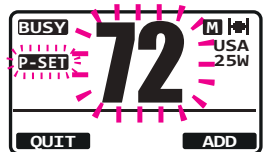

- Press the **[ADD]** soft key to program the channel into the preset channel.

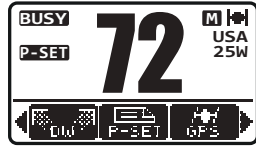

- Repeat steps 1 through 4 to program the desired channels into the preset channel bank. Up to 10 channels can be registered. If you attempt to register the 11th channel, error beep will sound.

9.11.2 Operation

- Press one of the soft keys.
- Press the **[◀]** or **[▶]** key repeatedly, until the **[P-SET]** soft key display, then press the **[P-SET]** soft key to recall the preset channel.
- Press the **[▲]** or **[▼]** key to select the desired preset channel.
- Press one of the soft keys, then press the **[P-SET]** soft key again to return to the last selected channel.



9.11.3 Deletion

- Press one of the soft keys.
- Press the **[◀]** or **[▶]** key repeatedly, until the **[P-SET]** soft key display, then press the **[P-SET]** soft key to recall the preset channel.
- Press one of the soft keys, then press and hold the **[P-SET]** soft key until the channel number blinks.
- Press the **[▲]** or **[▼]** key to select the preset channel to be deleted.
- Press the **[DELETE]** soft key to delete the channel from the preset channel bank.
- Repeat steps 4 through 5 to delete the desired channels from the preset channel bank.



10 DIGITAL SELECTIVE CALLING (DSC)

10.1 GENERAL

WARNING

The **GX1400** series is designed to generate digital maritime distress and safety calls to facilitate search and rescue. To be effective as a safety device, this equipment must be used only within communication range of a shore-based VHF marine channel 70 distress and safety watch system. The range of signal may vary, however under normal conditions should be approximately 20 nautical miles.

Digital Selective Calling (DSC) is a semi-automated method of establishing a radio call. It has been designated by the International Maritime Organization (IMO) as an international standard for establishing VHF, MF, and HF radio calls. It has also been designated as part of the Global Maritime Distress and Safety System (GMDSS). It is planned that DSC will eventually replace aural watches on distress frequencies and will be used to announce routine and urgent maritime safety information broadcasts.

This system allows mariners to instantly send a distress call with its own position, to the Coast Guard and other vessels within range of the transmission. DSC will also allow mariners to initiate or receive Distress, Urgency, Safety, Routine, Position Request, Position Report, and Group calls to or from another vessel equipped with a DSC transceiver.

10.2 DISTRESS ALERT

The GX1400 series is capable of transmitting and receiving DSC distress messages. Distress alert transmitted from the transceiver include the latitude and longitude of the vessel when valid GPS position data is being received.

10.2.1 Transmitting a DSC Distress Alert

NOTE

To be able to transmit a DSC distress alert, the MMSI number must be programmed, refer to section “**8.6.1 Maritime Mobile Service Identity (MMSI)**”.

In order for the ships location to be transmitted, the **GX1400** series must be able to receive a valid position data from the internal GPS receiver or other GPS device connected by NMEA 0183. Refer to section “**8.5.2 Accessory Cables**”.

Basic Operation

1. Lift the red spring loaded [DISTRESS] cover, then press and hold the [DISTRESS] key for 3 seconds. The “DISTRESS” screen will appear on the LCD and the radios display will count down (3-2-1) and then transmit the distress alert. The backlight of the LCD and keypad flashes while the radio's display is counting down.

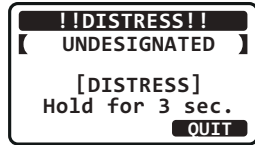

2. When the distress signal is sent, the transceiver watches for a transmission on CH70 until an acknowledgment signal (distress acknowledgment) is received.

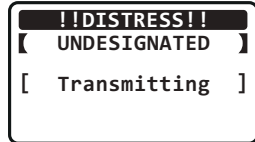

3. If no acknowledgment is received, the distress alert is repeated in 4 minute intervals until a acknowledgment is received.

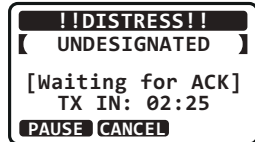

4. When a distress acknowledgment is received, a distress alarm sounds and Channel 16 is automatically selected. The display shows the MMSI of the ship responding to your distress.

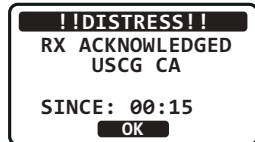

5. Press the microphone **PTT** switch and state your name, vessel name, number of persons on board and the distress situation, then say “**over**” and wait for a reply from the acknowledging ship.
6. To turn the distress alarm OFF before the radio retransmits the distress alert, press the [16/S] key or the [QUIT] soft key.

Transmitting a DSC Distress Alert with Nature of Distress

The **GX1400** series is capable of transmitting a DSC distress alert with the following “Nature of Distress” categories:

Undesignated, Fire/Explosion, Flooding, Collision, Grounding, Capsizing, Sinking, Adrift, Abandoning, Piracy, MOB.

1. [MENU] → “DSC” → “DIST ALERT MSG”

2. Press the **[NATURE]** soft key.
The “**NATURE OF DIST**” menu will appear on the display.
3. Press the **[▲]** or **[▼]** key to select the desired nature of distress category, then press the **[ENTER]** soft key.
4. Press and hold the **[DISTRESS]** key until a distress alert is transmitted.
5. Perform the steps 2 through 5 of the basic operation described in the previous section.

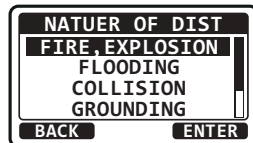
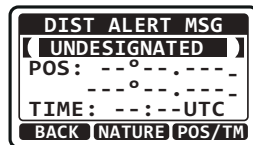

Transmitting a Distress Alert by Manually Inputting Location and Time

In case the **GX1400** series fails to get a GPS position fix, you may manually input your latitude and longitude, and time before transmitting the distress alert.

1. **[MENU]** → “**DSC**” → “**DIST ALERT MSG**”

2. Press the **[POS/TM]** soft key.

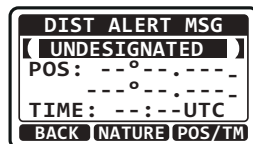

3. Press the **[▲]** or **[▼]** key to select the first number of latitude, then press the **[SELECT]** soft key to step to the next number.
4. Repeat step 3 to set the position and UTC time in the 24-hour format.

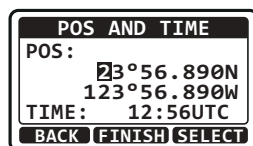

- If you make a mistake, press the **[◀]** or **[▶]** key until the wrong character is selected, then perform step 3.
5. When finished programming the position and time, press the **[FINISH]** soft key. The display will return to the previous screen.
 6. Press and hold the **[DISTRESS]** key until a distress alert is transmitted.
 7. Perform the steps 2 through 5 of the basic operation described in the previous section.

Pausing a Distress Alert

After a distress alert is transmitted, the distress alert is repeated every 4 minutes until the call is canceled by the user or until the radio is turned off and on again. The transceiver has provision to suspend (pause) the re-transmitting of the distress call by the procedure below.

1. After the distress call is transmitted, the radio will show the display as on the right.

Looking at this display you will notice “**TX IN: 02:25**”, this is the time when the radio will re-transmit the distress call.

2. To suspend re-transmitting the distress call, press the **[PAUSE]** soft key.
3. To resume counting down to transmit the distress call, press the **[RESUME]** soft key.

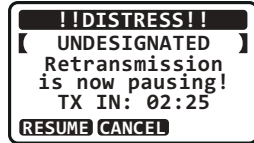
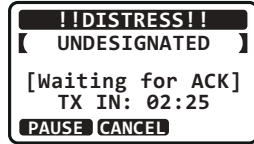

Canceling a DSC Distress Alert

If a distress alert was sent by error the transceiver allows you to send a message to other vessels to cancel the distress alert that was made.

1. Press the **[CANCEL]** soft key, then press the **[YES]** soft key.

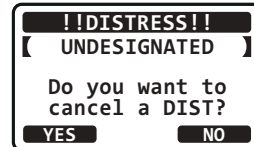

2. After the message for cancelling has been transmitted, press the **[OK]** soft key.



3. Press the **[FINISH]** soft key.

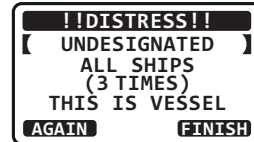

4. Press the **[QUIT]** soft key to return to radio operation.

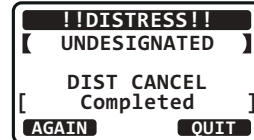

10.2.2 Receiving a Distress Alert

1. When a DSC distress alert is received, an emergency alarm sounds. The display will show the MMSI (or name) of the vessel transmitting the distress.
2. Press any key to stop the alarm.
3. On the display you will notice 3 soft key selections. These selections are described below:
[ACCEPT]: Press this key to accept the distress alert and to switch to Channel 16.

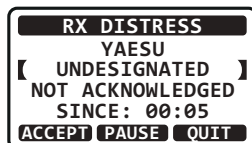

NOTE: If a key is not pressed for 30 seconds or longer the radio will automatically switch to Channel 16. ("AUTO CHANNEL CHANGE" timer settings can be changed in "DSC SETUP" menu. The default setting is 30 sec.)

[PAUSE]: Press this key to temporarily disable automatic switching to Channel 16.

[QUIT]: Press this key to quit the automatic Channel 16 switching and revert to the last selected working channel.

4. After accepting the distress call, press the [INFO] soft key to show information of the vessel in distress.
5. Press the [▲] or [▼] key to scroll the screen and see the MMSI (or name), nature of distress, and GPS position of the vessel in distress. If the received call does not include position data, the LCD will show "NO POSITION".
6. Press the [QUIT] soft key to return to radio operation mode.

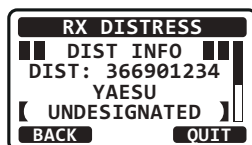
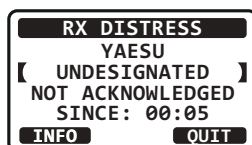

NOTE

- You must continue monitoring Channel 16 as a coast station may require assistance in the rescue attempt.
- When there is an unread distress alert, "✉" icon will appear on the display. You may review the unread distress alert from the DSC log, refer to the section "10.11.2 Reviewing a Logged DSC Distress Call".



10.3 ALL SHIPS CALL

The all ships call function allows contact to be established with DSC equipped vessels without having their MMSI in the individual calling directory. Also, priority for the call can be designated as “SAFETY” or “URGENCY”.

SAFETY Call: This type of call is used to transmit boating safety information to other vessels. This message usually contains information about an overdue boat, debris in the water, loss of a navigation aid or an important meteorological message. This call is the same as saying “Securite, Securite, Securite”.

URGENCY Call: This type of call is used when a vessel may not truly be in distress, but have a potential problem that may lead to a distress situation. This call is the same as saying “PAN PAN, PAN PAN, PAN PAN” on Channel 16.

10.3.1 Transmitting an All Ships Call

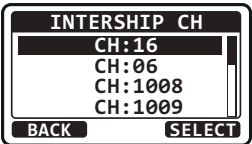
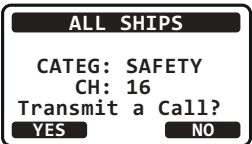
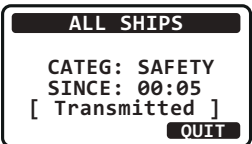
1.  → “DSC” → “ALL SHIPS”
2. Press the [▲] or [▼] key to select the category of the call (“SAFETY” or “URGENCY”), then press the [SELECT] soft key.

3. Press the [▲] or [▼] key to select the operating channel you want to communicate on, then press the [SELECT] soft key.

4. Press the [YES] soft key to transmit the selected type of all ships call.

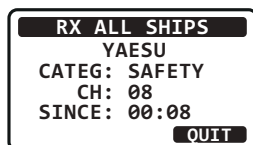
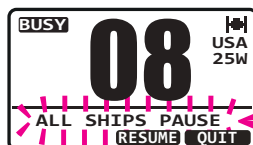
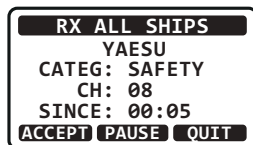
5. After the all ships call is transmitted, the transceiver will switch to the channel which selected on the step 3 above, with no change of the display. To change the display, press the [QUIT] soft key.

6. Listen to the channel to make sure it is not busy, then key the microphone and say “PAN PAN, PAN PAN, PAN PAN” or “Securite, Securite, Securite” depending on the priority of the call. Say your call sign and announce the channel you wish to switch to for communications.

10.3.2 Receiving an All Ships Call

1. When an all ships call is received, an emergency alarm sounds.
The display will show the MMSI (or name) of the vessel transmitting the all ships call.
2. Press any key on the radio to stop the alarm.
3. To immediately switch to requested channel, press the **[ACCEPT]** soft key.
If a key is not pressed for thirty seconds (by default; refer to the section “**10.3.8 Auto Channel Switching Time**”) after an all ships call is received, the transceiver will automatically switch to the requested channel for you to monitor communications.
4. Press the **[PAUSE]** soft key to suspend the acknowledgement.
Press the **[RESUME]** soft key to resume the acknowledgement.
5. If you want the radio to stay on the channel you were on before receiving the all ships call, press the **[QUIT]** soft key.
6. Press the **[▲]** or **[▼]** key to scroll the screen and see the MMSI (or name) of the calling vessel, category of the call and requested operating channel.
7. Press the **[QUIT]** soft key to display the operating channel number of the requested channel.
8. Press the **PTT** switch on the microphone and talk to the calling vessel.



10.3.3 Setting up the All Ships Call Ringer

The transceiver has the capability to turn off the all ships call ringer.

1. **[MENU]** → “**SETUP**” → “**DSC SETUP**” → “**DSC BEEP**”
2. Select “**ALL SHIPS**” with the **[▲]** or **[▼]** key, then press the **[SELECT]** soft key.

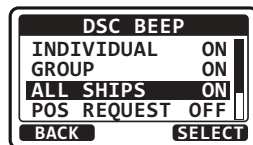

- Press the [▲] or [▼] key to select “OFF”, then press the ENTER soft key.

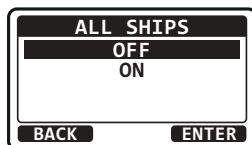

- Press the [16/S] key or press the [CLR] soft key to return to radio operation mode.

If you wish to return to enabling the ringer tone, just repeat the above procedure, pressing the [▲] or [▼] key to select “ON” in step 3 above.

10.4 INDIVIDUAL CALL

This feature allows the **GX1400** series to contact another vessel with a DSC VHF radio and automatically switch the receiving radio to the desired communications channel. This feature is similar to calling a vessel on CH16 and requesting to go to another channel (switching to the channel is private between the two vessels). Up to 60 individual contacts may be programmed.

10.4.1 Setting up the Individual / Position Call Directory

The transceiver has a DSC individual directory that allows storing vessels or persons names and the associated MMSI numbers you may wish to contact via individual calls, auto polling, position request, position report, and polling transmissions.

To transmit an individual call, you must program this directory with information of the persons you wish to call, similar to a cellular phone contact list.

- [MENU] → “SETUP” → “DSC SETUP” → “INDIVIDUAL DIR.”

- Select “ADD” with the [▲] or [▼] key, then press the [SELECT] soft key.

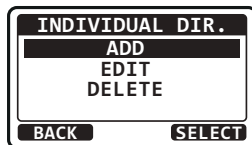

- Select “NAME” with the [▲] or [▼] key, then press the [SELECT] soft key.

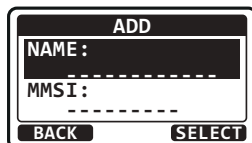

- Press the [▲] or [▼] key to scroll to the first letter of the name of the vessel or person you want to list in the directory.

- Press the [SELECT] soft key to store the first letter of the name and step to the next letter to the right.



6. Repeat steps 4 and 5 until the name is complete.
Press the [▶] key to move to the next space if you want to enter a blank space in the name.
If a mistake was made entering in the name, press the [◀] or [▶] key repeatedly until the wrong letter is highlighted, then press the [▲] or [▼] key to correct the entry.
7. After the twelfth letter or space has been entered, press the [FINISH] soft key to return to the previous screen.
8. Select "MMSI" with the [▲] or [▼] key, then press the [SELECT] soft key.
9. Press the [▲] or [▼] key to scroll through numbers, 0 to 9.
10. Press the [SELECT] soft key to store the number and step to the next digit to the right.
11. Repeat steps 9 and 10 until the MMSI is complete.
If a mistake was made entering in the MMSI number, press the [◀] or [▶] key repeatedly until the wrong number is highlighted, then press the [▲] or [▼] key to correct the entry.
12. After the ninth number has been entered, press the [FINISH] soft key to return to the previous screen.
13. Press the [FINISH] soft key to save the entered address.
14. To enter another individual address, repeat steps 2 through 13.
15. Press the [16/S] key or press the [CLR] soft key to return to radio operation mode.

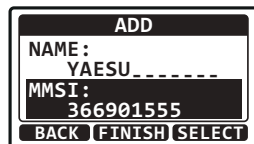
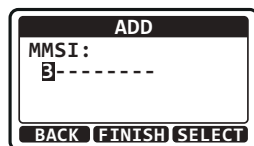

10.4.2 Setting up Individual Call Reply

This menu item sets up the radio to manually (default setting) or automatically respond to a DSC individual call requesting you to switch to a working channel for voice communications. When "MANUAL" is selected the MMSI of the calling vessel is shown allowing you to see who is calling. This function is similar to caller ID on a cellular phone.

1. [MENU] → "SETUP" → "DSC SETUP" → "INDIVIDUAL REPLY"

2. Press the [▲] or [▼] key to select “**AUTO**” or “**MANUAL**”, then press the [ENTER] soft key.

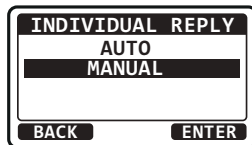

3. Press the [16/S] key or press the [CLR] soft key to return to radio operation mode.

10.4.3 Setting up the Individual Call Acknowledgment

The transceiver can select either reply message “**ABLE**” (default) or “**UNABLE**” when the individual reply setting (described previous section) is set to “**AUTO**”.

1. [MENU] → “**SETUP**” → “**DSC SETUP**” → “**INDIVIDUAL ACK**”

2. Press the [▲] or [▼] key to select “**ABLE**” or “**UNABLE**”, then press the [ENTER] soft key.

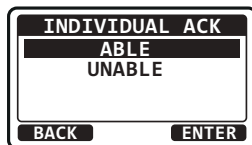

3. Press the [16/S] key or press the [CLR] soft key to return to radio operation mode.

10.4.4 Transmitting an Individual Call

This feature allows you to contact another vessel, switch their radio to a requested working channel and ring like a telephone. This feature is similar to calling a vessel on CH16 and requesting to go to another channel.

Individual Call from Individual / Position Call Directory

1. [MENU] → “**DSC**” → “**INDIVIDUAL**”

2. Press the [▲] or [▼] key to select “**HISTORY**” or “**MEMORY**”, then press the [SELECT] soft key.

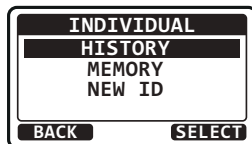

3. Press the [▲] or [▼] key to select an individual you want to contact, then press the [SELECT] soft key.

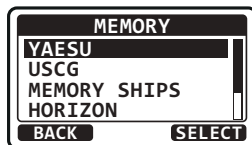

- Press the [▲] or [▼] key to select the operating channel you want to communicate on and press the [SELECT] soft key.

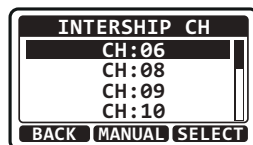

- Press the [YES] soft key to transmit the individual DSC signal.

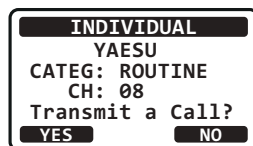

- After an individual call is transmitted, if the reply signal is not received, "Waiting for ACK" is shown on the display which means the transceiver is waiting for the vessel you called to send an acknowledgement.

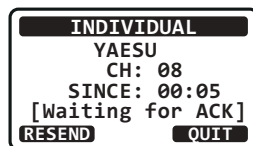

To transmit the call again, press the [RESEND] soft key.

- When the transceiver receives an acknowledgement from the vessel you called, the radio will automatically switch to the operating channel selected in step 6 and produce a ringing sound.
- Key the microphone and call the other vessel you desire to communicate with.

Individual Call by Manually Entering an MMSI

You may enter an MMSI number manually to contact a vessel without storing the MMSI in the individual directory.

- [MENU] → "DSC" → "INDIVIDUAL"

- Press the [▲] or [▼] key to select "NEW ID", then press the [SELECT] soft key.

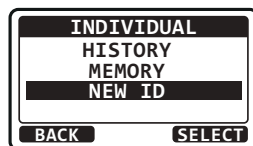

- Press the [▲] or [▼] key to scroll through numbers, 0 to 9.
- Press the [SELECT] soft key to store the number and step to the next digit to the right.



- Repeat steps 3 and 4 until the MMSI is complete.
If a mistake was made entering in the MMSI number, press the [◀] or [▶] key repeatedly until the wrong number is highlighted, then press the [▲] or [▼] key to correct the entry.

- After the ninth number has been entered, press the **[FINISH]** soft key.
- Press the **[▲]** or **[▼]** key to select the operating channel you want to communicate on and press the **[SELECT]** soft key.

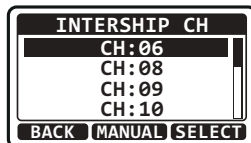

- Press the **[YES]** soft key to transmit the individual DSC signal.

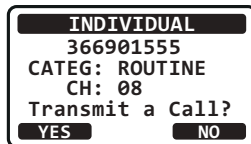

- After an individual call is transmitted, if the reply signal is not received, **“Waiting for ACK”** is shown on the display which means the transceiver is waiting for the vessel you called to send an acknowledgement. To transmit the call again, press the **[RESEND]** soft key.
- When the transceiver receives an acknowledgement from the vessel you called, the radio will automatically switch to the operating channel selected in step 9 and produce a ringing sound.
- Key the microphone and call the other vessel you desire to communicate with.

10.4.5 Receiving an Individual Call

When receiving an individual call, an acknowledgment must be sent back to the calling station. The transceiver in the default setting will automatically respond to the calling station and switch to the requested channel for voice communications. Refer to the section **“10.4.2 Setting up Individual Call Reply”** if you want to change the setting to see who is calling before replying to the call.

Manual reply (Default setting):

- When an individual call is received, a ringing alarm sounds. The display shows the MMSI or the name of the vessel transmitting the individual call.
- Press any key to stop the alarm.
- Press the **[ACCEPT]** soft key to accept the call.

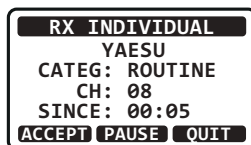

- Press the **[PAUSE]** soft key to suspend the acknowledgement. Press the **[RESUME]** soft key to resume the acknowledgement.



- After accepting the call, press the **[ABLE]** soft key to switch to the requested channel. (To inform that you cannot respond, press the **[UNABLE]** soft key.)

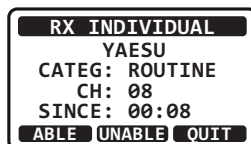

- Press the **[YES]** soft key to send an acknowledgement. Press the **[CHG CH]** soft key to change the channel for communication from the requested one.

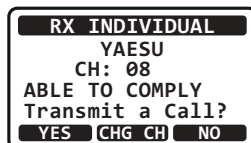

- After sending the acknowledgement, the transceiver switches to the requested channel or to the channel selected in step 6, without changing the display. To change the display, press the **[QUIT]** soft key.

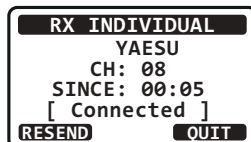

- Monitor the channel to make sure it is clear, then press the **PTT** switch on the microphone and talk to the calling vessel.

Automatic reply:

- When an individual call is received, a ringing alarm sounds. The transceiver automatically switches to the requested channel. The display shows the MMSI or the name of the vessel transmitting the individual call.
- Press any key to stop the alarm.
- Press the **[QUIT]** soft key to return to radio operation.
- Monitor the channel to make sure it is clear, then press the **PTT** switch on the microphone and talk to the calling vessel.

10.4.6 Setting up the Individual Call Ringer

When an individual call is received the radio will produce a ringing tone for 2 minutes (by default). This selection allows the individual call ringer time to be changed.

- [MENU]** → **"SETUP"** → **"DSC SETUP"** → **"INDIVIDUAL RING"**

- Press the **[▲]** or **[▼]** key to select ringing time of an individual call, then press the **[ENTER]** soft key.

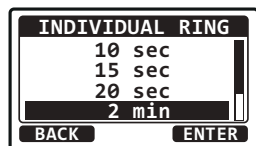

- Press the **[16/S]** key or press the **[CLR]** soft key to return to radio operation mode.

The transceiver has the capability to turn off the individual call ringer.

1.  → "SETUP" → "DSC SETUP" → "DSC BEEP"

2. Select "DSC BEEP" with the [▲] or [▼] key, then press the [SELECT] soft key.

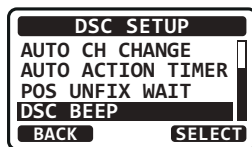

3. Select "INDIVIDUAL" with the [▲] or [▼] key, then press the [SELECT] soft key.

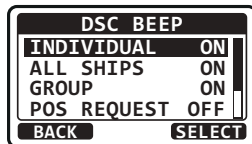

4. Press the [▲] or [▼] key to select "OFF", then press the [ENTER] soft key.

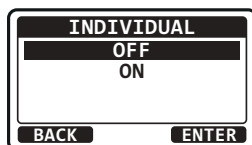

5. Press the [16/S] key or press the [CLR] soft key to return to radio operation mode.

If you wish to return to enabling the ringer tone, just repeat the above procedure, pressing the [▲] or [▼] key to select "ON" in step 4 above.

10.5 GROUP CALL

This feature allows users to automatically contact a specific group of vessels using DSC radios with the group call function. The called radios can automatically switch to the desired channel for voice communications. This function is very useful for yacht clubs and vessels traveling together that want to make communal announcements on a predetermined channel. Up to 30 group MMSIs may be programmed.

10.5.1 Setting up a Group Call

For this function to operate the same group MMSI must be programmed into all the DSC VHF radios within the group of vessels that will be using this feature. To understand about group MMSI programming, first a Ship MMSI has to be understood.

Ship MMSI: The first three digits called a MID (Mobile Identity Group) of a ship MMSI denote the country the ship registered for a MMSI. The last 6 digits are specific to the ships ID.

Ship MMSI Example: If your MMSI is "366123456", "366" is MID which denote the country and "123456" is the vessel's MMSI.

Group MMSI:

- ❑ Group MMSI numbers are not assigned by the FCC or other organizations licensed to assign ship MMSI numbers.
- ❑ The first digit of a group MMSI is always set to “0” by the international rules. All Standard Horizon radios are preset so when programming a group MMSI the first digit is set to “0”.
- ❑ The USCG recommends programming the MID of a ships MMSI into the second, third and fourth digits of the group MMSI as it denotes the area the ship is located in.
- ❑ The last 5 digits are decided upon by persons in the group. This is an important step as all radios in the group must contain the same group MMSI so they can be contacted by each other. There is a chance that another group of vessels may program in the same group MMSI. If this happens, simply change one or more of the last 5 digits of the group MMSI.

1. [MENU] → “SETUP” → “DSC SETUP” → “GROUP DIR.”

2. Press the [▲] or [▼] key to select “ADD”, then press the [SELECT] soft key.



3. Press the [▲] or [▼] key to select “NAME:”, then press the [SELECT] soft key.

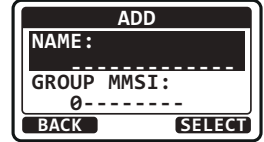

4. Press the [▲] or [▼] key to scroll through the first letter of the group name you want to reference in the directory.

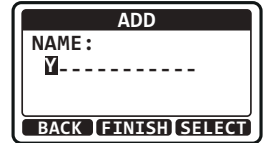

5. Press the [SELECT] soft key to store the first letter in the name and step to the next letter to the right.

6. Repeat steps 4 and 5 until the name is complete.

Press the [▶] key to move to the next space if you want to enter a blank space in the name.

If a mistake was made entering in th name, press the [◀] or [▶] key repeatedly until the wrong letter is highlighted, then press the [▲] or [▼] key to correct the entry.

7. After the twelfth letter or space has been entered, press the [FINISH] soft key to return to the previous screen.

8. Select “**GROUP MMSI:**” with the [▲] or [▼] key, then press the [SELECT] soft key.

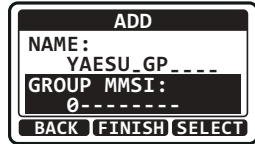

9. Press the [▲] or [▼] key to scroll through numbers, 0 to 9.
10. Press the [SELECT] soft key to store the number and step to the next digit to the right.

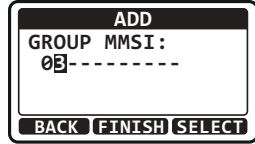

11. Repeat steps 9 and 10 until the group MMSI is complete. If a mistake was made entering in the MMSI number, press the [◀] or [▶] key repeatedly until the wrong number is highlighted, then press the [▲] or [▼] key to correct the entry.
12. After the ninth number has been entered, press the [FINISH] soft key to return to the previous screen.
13. Press the [FINISH] soft key to save the entered data.

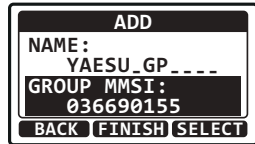

14. To enter another group entry, repeat steps 2 through 13.
15. Press the [16/S] key or press the [CLR] soft key to return to radio operation mode.

10.5.2 Transmitting a Group Call

Group Call from Group Call Directory

1. [MENU] → "DSC" → "GROUP"
2. Press the [▲] or [▼] key to select “**HISTORY**” or “**MEMORY**”, then press the [SELECT] soft key.
3. Press the [▲] or [▼] key to select a group you want to contact, then press the [SELECT] soft key.

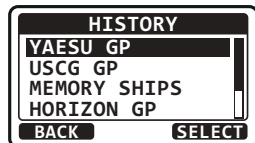
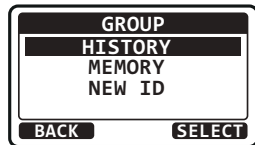

4. Press the [▲] or [▼] key to select the operating channel you want to communicate on and press the [SELECT] soft key.

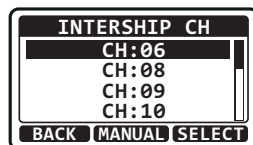

5. Press the [YES] soft key to transmit the group call signal.

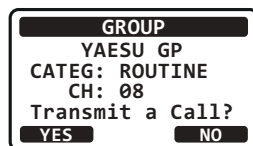

6. After the group call is transmitted, the transceiver will switch to the channel selected in step 6 above, without changing the display. To change the display, press the [QUIT] soft key.

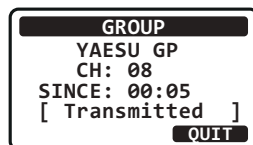

7. Listen to the channel to make sure it is not busy, then key the microphone and call the other vessels you desire to communicate with.

Group Call by Manually Entering an MMSI

You may enter an MMSI number manually to contact a vessel without storing the MMSI in the Group Call Directory.

1. [MENU] → "DSC" → "GROUP"

2. Press the [▲] or [▼] key to select "NEW ID", then press the [SELECT] soft key.

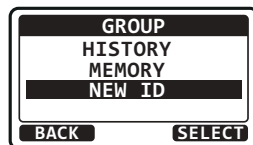

3. Press the [▲] or [▼] key to scroll through numbers, 0 to 9.

4. Press the [SELECT] soft key to store the number and step to the next digit to the right.



5. Repeat steps 3 and 4 until the MMSI is complete.
If a mistake was made entering in the MMSI number, press the [◀] or [▶] key repeatedly until the wrong number is highlighted, then press the [▲] or [▼] key to correct the entry.
6. After the ninth number has been entered, press the [FINISH] soft key.

- Press the [▲] or [▼] key to select the operating channel you want to communicate on and press the [SELECT] soft key.

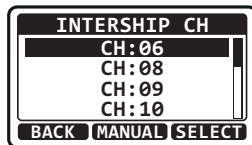

- Press the [YES] soft key to transmit the group call signal.

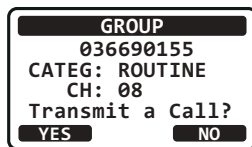

- After the group call is transmitted, the transceiver will switch to the channel selected in step 7, without changing the display. To change the display, press the [QUIT] soft key.
- Listen to the channel to make sure it is not busy, then key the microphone and call the other vessels you desire to communicate with.

10.5.3 Receiving a Group Call

- When a group call is received, the transceiver will produce a ringing alarm sound. (DSC BEEP needs to be enabled to hear alarm.)
The display will show the MMSI (or name) of the vessel transmitting the group call.
- Press any key to stop the alarm.
- To immediately switch to requested channel, press the [ACCEPT] soft key.

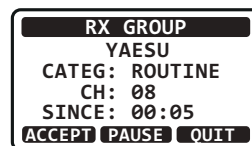

If a key is not pressed for thirty seconds after a group call is received, the transceiver will automatically switch to the requested channel for you to monitor communications.

- Press the [PAUSE] soft key to suspend the acknowledgement.
Press the [RESUME] soft key to resume the acknowledgement.



- If you want the radio to stay on the channel you were on before receiving the group call, press the [QUIT] soft key.

6. Press the [▲] or [▼] key to scroll the screen and see the MMSI (or name) of the calling vessel, category of the call and requested operating channel.
7. Press the [QUIT] soft key to display the operating channel number of the requested channel.
8. Listen to the channel for the person calling the group for a message.
9. If you want to respond, monitor the channel to make sure it is clear, then press the **PTT** switch on the microphone and talk to the calling ship(s).

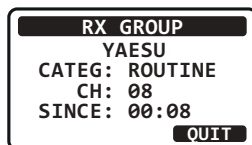

NOTE

- When there is an unread group call, the “✉” icon will appear on the display. You may review the unread group call from the DSC log, refer to section “10.11.3 Reviewing a Logged Other Calls”.
- After a group call is received, the time the call was made and the ships MMSI or vessels name will appear on the LCD.

10.5.4 Setting up the Group Call Ringer

The transceiver has the capability to turn off the group call ringer.

1. [MENU] → “SETUP” → “DSC SETUP” → “DSC BEEP”

2. Select “**GROUP**” with the [▲] or [▼] key, then press the [SELECT] soft key.

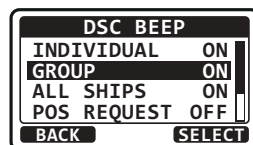

3. Press the [▲] or [▼] key to select “**OFF**”, then press the [ENTER] soft key.

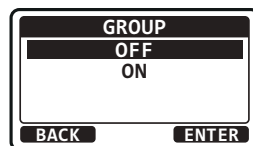

4. Press the [16/S] key or press the [CLR] soft key to return to radio operation mode.

If you wish to return to enabling the ringer tone, just repeat the above procedure, pressing the [▲] or [▼] key to select “**ON**” in step 3 above.

10.6 POSITION REQUEST

Advancements in DSC have made it possible to poll the location of another vessel and show the position of that vessel on the display of the transceiver. Standard Horizon has taken this feature one step further, if any Standard Horizon GPS is connected to the transceiver, the polled position of the vessel is shown on the display of the GPS chart plotter making it easy to navigate to the location of the polled vessel. This is a great feature for anyone wanting to know the position of another vessel. For example your friend that is catching fish, or finding the location of a person you are cruising with.

NOTE

The other vessel must have an operating GPS receiver connected to its DSC transceiver and must not have its transceiver set to deny position requests. (Refer the section “**10.4.1 Setting up the Individual / Position Call Directory**” to enter information into the individual directory).

10.6.1 Transmitting a Position Request to Another Vessel

Position Request from Individual / Position Call Directory

1. [MENU] → “DSC” → “POS REQUEST”
2. Press the [▲] or [▼] key to select “**HISTORY**” or “**MEMORY**”, then press the [SELECT] soft key.
3. Press the [▲] or [▼] key to select an individual you want to contact, then press the [SELECT] soft key.
4. Press the [YES] soft key to transmit the position request call.
5. If the **GX1400** does not receive a reply, the display will be as shown in the illustration on the right. To send again, press the [RESEND] soft key.

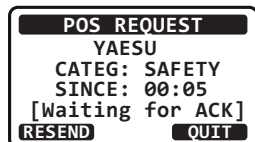
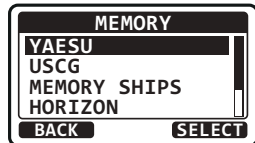

- When the transceiver receives the position from the polled vessel, the transceiver will produce a ringing alarm sound and the position from the polled vessel is sent to a GPS chart plotter via NMEA 0183. (DSC BEEP needs to be enabled to hear alarm.)

Press any key to stop the alarm.

- Press the **[INFO]** soft key to show the position data transferred from the polled vessel on the display.

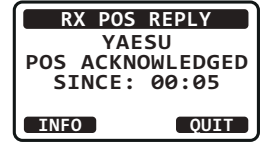

- Press the **[▲]** or **[▼]** key to change the display to view the received data.

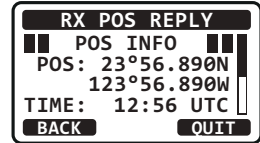

- To exit from position request display, press the **[QUIT]** soft key.

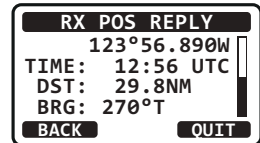

NOTE

If the transceiver does not receive position data from the polled vessel, the position and time of LCD will show "--".

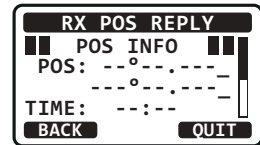

Position Request by Manually Entering an MMSI

You may enter an MMSI number manually to contact a vessel without storing the MMSI in the individual/position call directory.

- [MENU]** → "DSC" → "POS REQUEST"

- Press the **[▲]** or **[▼]** key to select "NEW ID", then press the **[SELECT]** soft key.



- Press the [▲] or [▼] key to scroll through numbers, 0 to 9.
- Press the [SELECT] soft key to store the number and step to the next digit to the right.

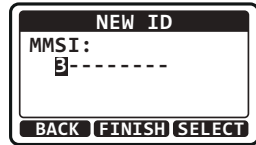

- Repeat steps 3 and 4 until the MMSI is complete. If a mistake was made entering in the MMSI number, press the [◀] or [▶] key repeatedly until the wrong number is highlighted, then press the [▲] or [▼] key to correct the entry.
- After the ninth number has been entered, press the [FINISH] soft key.
- Press the [YES] soft key to transmit the position request call.

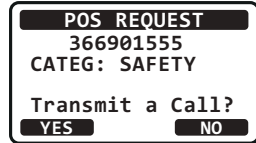

- If the transceiver does not receive a reply, the display will be as shown in the illustration on the right. To send again, press the [RESEND] soft key.



- When the transceiver receives the position from the polled vessel, the transceiver will produce a ringing alarm sound and the position from the polled vessel is sent to a GPS chart plotter via NMEA 0183. (DSC BEEP needs to be enabled to hear alarm.)

Press any key to stop the alarm.

- Press the [INFO] soft key to show the position data transferred from the polled vessel on the display.

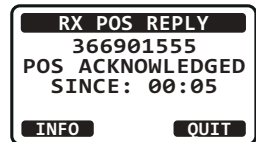

- Press the [▲] or [▼] key to change the display to view the received data.
- To exit from position request display, press the [QUIT] soft key.

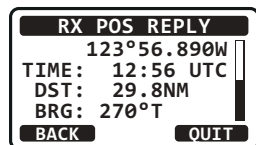
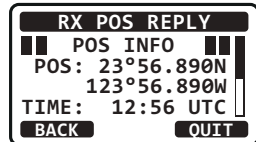

10.6.2 Receiving a Position Request

When a position request call is received from another vessel, a ringing alarm will sound and “**POS REQUEST**” will be shown in the LCD.

1. When a position request call is received, the transceiver will transmit your position to the vessel who requested it.
2. To exit from position request display, press the [QUIT] soft key.

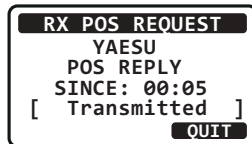

10.6.3 Setting up the Position Request Ringer

The transceiver has the capability to turn off the position request ringer.

1. [MENU] → "SETUP" → "DSC SETUP" → "DSC BEEP"

2. Select "POS REQUEST" with the [▲] or [▼] key, then press the [SELECT] soft key.

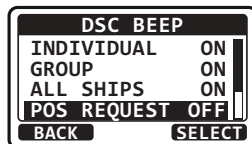

3. Press the [▲] or [▼] key to select "OFF", then press the [ENTER] soft key.

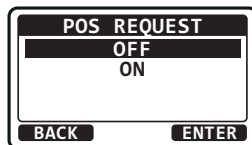

4. Press the [16/S] key or press the [CLR] soft key to return to radio operation mode.

If you wish to return to enabling the ringer tone, just repeat the above procedure, pressing the [▲] or [▼] key to select "ON" in step 3 above.

10.7 POSITION REPORT

The feature is similar to the position request, however instead of requesting a position of another vessel this function allows you to send your position to another vessel. In order to send your position you need to have a GPS receiver connected or to have manually input your position. See section "9.9 MANUAL INPUTTING OF THE GPS LOCATION."

10.7.1 Transmitting a DSC Position Report Call

Position Report from Individual / Position Call Directory

1.  → "DSC" → "POS REPORT"
2. Press the [▲] or [▼] key to select "HISTORY" or "MEMORY", then press the [SELECT] soft key.
3. Press the [▲] or [▼] key to select an individual you want to contact, then press the [SELECT] soft key.
4. Press the [YES] soft key to send your position to the selected vessel.
Press the POS soft key to change the position information.
5. To exit from position request display, press the [QUIT] soft key.

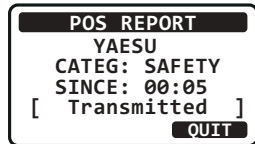
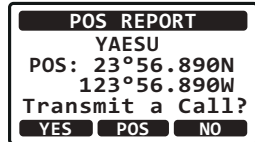
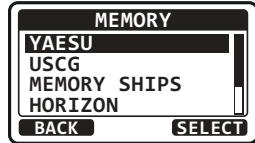
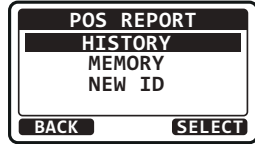

DSC Position Report Call by Manually Entering an MMSI

You may enter an MMSI number manually to contact a vessel without storing the MMSI in the individual/position call directory.

1.  → "DSC" → "POS REPORT"
2. Press the [▲] or [▼] key to select "NEW ID", then press the [SELECT] soft key.
3. Press the [▲] or [▼] key to scroll through numbers, 0 to 9.
4. Press the [SELECT] soft key to store the number and step to the next digit to the right.

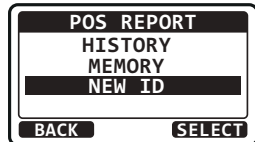

5. Repeat steps 3 and 4 until the MMSI is complete.
If a mistake was made entering in the MMSI number, press the [◀] or [▶] key repeatedly until the wrong number is highlighted, then press the [▲] or [▼] key to correct the entry.
6. After the ninth number has been entered, press the **[FINISH]** soft key.
7. Press the **[YES]** soft key to send your position to the selected vessel.
Press the **[POS]** soft key to change the position information.
8. To exit from position request display, press the **[QUIT]** soft key.

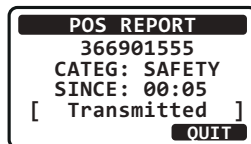
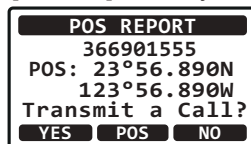

10.7.2 Receiving a DSC Position Report Call

When another vessel transmits their location to the transceiver the following will happen:

1. When the position report call is received, a ringing sound will be produced and the display shows the vessels MMSI or name, how long since the call was received and the GPS position of the vessel. The transceiver will also output NMEA sentences (DSC and DSE) to a connected GPS chart plotter.
2. Press any key on the radio to stop the alarm. (DSC BEEP needs to be enabled to hear alarm.)
3. Press the **[INFO]** soft key to show the position data transferred from the calling vessel.
4. Press the [▲] or [▼] key to change the display to view the received data.
5. To exit from position request display, press the **[QUIT]** soft key.

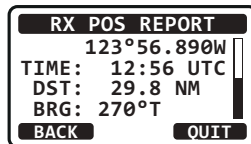
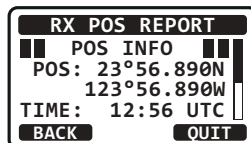
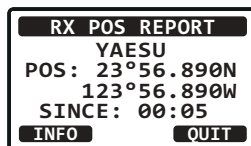

10.7.3 Setting up a Position Report Ringer

The transceiver has the capability to turn off the position report ringer.

1. **[MENU]** → “**SETUP**” → “**DSC SETUP**” → “**DSC BEEP**”

2. Select “**POS REPORT**” with the **[▲]** or **[▼]** key, then press the **[SELECT]** soft key.

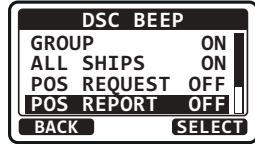

3. Press the **[▲]** or **[▼]** key to select “**OFF**”, then press the **[ENTER]** soft key.

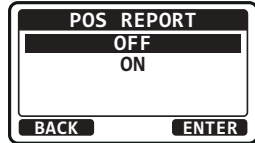

4. Press the **[16/S]** key or press the **[CLR]** soft key to return to radio operation mode.

To enable the position report ringer, repeat the above procedure, pressing the **[▲]** or **[▼]** key to select “**ON**” in step 3 above.

10.8 MANUAL INPUT OF THE GPS LOCATION (LAT/LON)

You may send the latitude and longitude of your vessel manually when a GPS receiver is not connected or is not functioning.

After the position is entered, transmitting a DSC distress or position report will contain the manually entered position.

1. **[MENU]** → “**DSC**” → “**MMSI/POS INFO**”

2. Press the **[POS/TM]** soft key to display the position input screen.

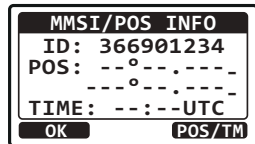

3. Press the **[▲]** or **[▼]** key to select the first digit of your latitude, then press the **[SELECT]** soft key to step to the next digit.

4. Repeat step 3 to enter your latitude and longitude.

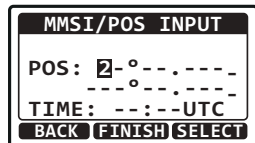

5. Enter UTC time in the 24-hour format with the same procedure in step 3.

- If a mistake was made entering in the position and time, press the [◀] or [▶] key until the wrong letter is highlighted, then press the [▲] or [▼] key to correct the entry and press the [SELECT] soft key.

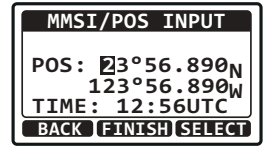

- When finished programming the position information, press the [FINISH] soft key.

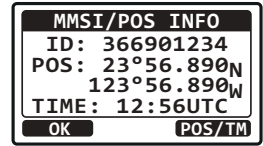

- Press the [OK] soft key to return to the MENU screen. Press the [POS/TM] soft key to display the position input screen again.
- Press the [16/S] key or press the [CLR] soft key to return to radio operation mode.

10.9 AUTO POS POLLING

The **GX1400** series has the capability to automatically track 6 stations programmed into the individual directory.

10.9.1 Setting up the Polling Call Type

- [MENU] → "SETUP" → "DSC SETUP" → "AUTO POS POLLING"

- Press the [▲] or [▼] key to select "POS REQUEST" or "POS REPORT", then press the [ENTER] soft key.

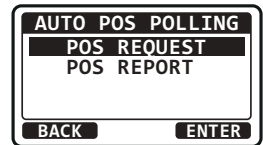

- Press the [BACK] soft key to return to "DSC SETUP".

10.9.2 Setting up the Polling Time Interval

- [MENU] → "SETUP" → "DSC SETUP" → "AUTO POS TIME"

- Press the [▲] or [▼] key to select the desired interval time, then press the [ENTER] soft key.

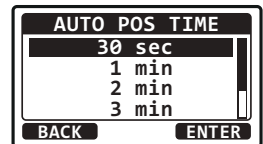

- Press the [16/S] key or press the [CLR] soft key to return to radio operation mode.

10.9.3 Selecting Stations to be Automatically Polled

1. **[MENU] → “DSC” → “AUTO POS POLLING” → “AUTO POS POLLING”**

2. Press the [▲] or [▼] key to select “**SELECT ID**”, then press the [SELECT] soft key.

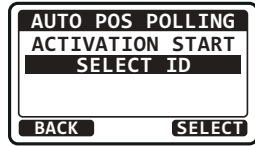

3. Press the [▲] or [▼] key to select the list number, then press the [SELECT] soft key.

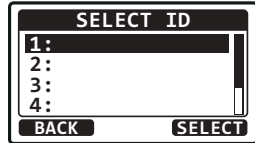

4. Press the [▲] or [▼] key to select an individual you want to poll, then press the [SELECT] soft key.

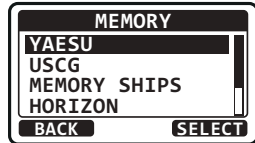

5. Repeat steps 3 and 4 for all the desired individual to be polled.

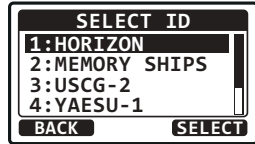

6. Press the [BACK] soft key to return to “**AUTO POS POLLING**”.

10.9.4 Enabling/Disabling Auto POS Polling

1. **[MENU] → “DSC” → “AUTO POS POLLING” → “AUTO POS POLL”**

2. Press the [▲] or [▼] key to select “**ACTIVATION START**”, then press the [SELECT] soft key.

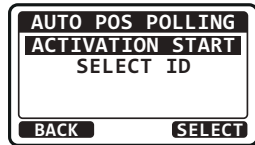

3. Press the [▲] or [▼] key to select “**START**”, then press the [SELECT] soft key.



4. Press the [16/S] key or press the [CLR] soft key to return to radio operation mode.

To disable the auto position polling, repeat the above procedure, pressing the [▲] or [▼] key to select “STOP” in step 3 above.

The “A” indicator will appear on the LCD while the auto position polling is activated.

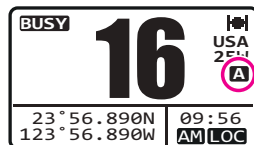

10.10 DSC TEST CALL

This function is used to contact another DSC equipped vessel to ensure the DSC functions of the radio are operating correctly.

10.10.1 Transmitting a DSC Test Call

DSC Test Call from Individual / Position Call Directory

1. [MENU] → “DSC” → “TEST CALL” → “MEMORY”

2. Press the [▲] or [▼] key to select an individual you want to contact, then press the [SELECT] soft key.

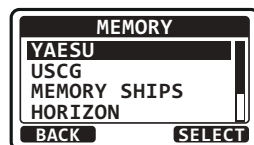

3. Press the [YES] soft key to transmit the test signal.

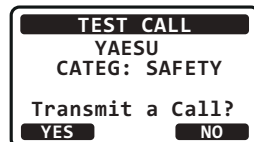

4. After the DSC test call is transmitted, the transceiver waits for a reply from the radio which was called, and the display will show “WAITING FOR ACK”.

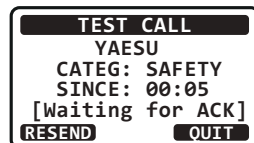

To transmit again, press the [RESEND] soft key.

5. When an acknowledgement signal is received, the transceiver will show “RX TEST CALL” screen, which confirms the radio you called has received the test call.

6. Press the [QUIT] soft key to return to the radio operation.

DSC Test Call by Manually Entering an MMSI

1. [MENU] → "DSC" → "TEST CALL" → "NEW ID"

2. Press the [▲] or [▼] key to scroll through numbers, 0 to 9.

3. Press the [SELECT] soft key to store the number and step to the next digit to the right.



4. Repeat steps 2 and 3 until the MMSI is complete.

If a mistake was made entering in the MMSI number, press the [◀] or [▶] key repeatedly until the wrong number is highlighted, then press the [▲] or [▼] key to correct the entry.

5. After the ninth number has been entered, press the [FINISH] soft key.

6. Press the [YES] soft key to transmit the test signal.

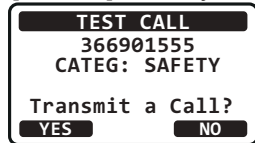

7. After the DSC test call is transmitted, the transceiver waits for a reply from the radio which was called, and the display will show "WAITING FOR ACK".

To transmit again, press the [RESEND] soft key.

8. When an acknowledgement signal is received, the display will show "Received ACK".

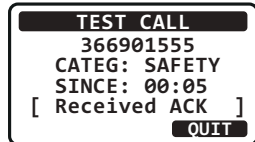
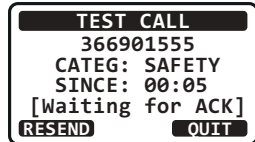

9. Press the [QUIT] soft key to return to the radio operation.

10.10.2 Receiving a DSC Test Call

When another vessel transmits a DSC test call to the transceiver, the radio automatically reply an acknowledgement. The display shows the MMSI or the name of the vessel transmitting the DSC test call.

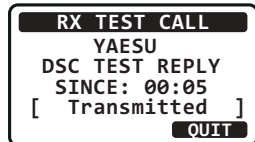

Press the [QUIT] soft key to return to radio operation.

10.11 DSC LOG OPERATION

The **GX1400** series logs transmitted DSC calls, received distress calls, and other calls (individual, group, all ships, etc.). The DSC log feature is similar to an answer machine where calls are recorded for review and a “☑” icon will appear on the radio’s display. The transceiver can store up to the latest 30 transmitted calls, up to the latest 30 distress calls, and up to the latest 50 other calls.

NOTE

When the “**DSC LOG**” [MENU] is selected, the transceiver will display the highest priority logged calls automatically.

10.11.1 Reviewing a Logged Transmitted Call

1. [MENU] → “DSC” → “DSC LOG”

2. Press the [▲] or [▼] key to select “**TRANSMITTED LOG**”, then press the [SELECT] soft key.



3. Press the [▲] or [▼] key to select the station (name or MMSI number) you want to review the call, then press the [SELECT] soft key.

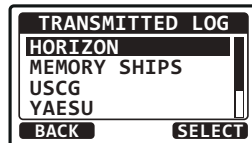

4. Press the [▲] or [▼] key to scroll the display.

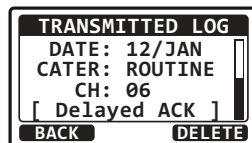
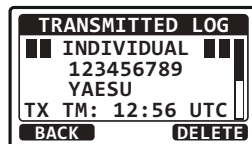

5. Press the [BACK] soft key to go back to the DSC transmitted call list.

10.11.2 Reviewing a Logged DSC Distress Call

1. [MENU] → “DSC” → “DSC LOG”

- Press the [▲] or [▼] key to select “**DISTRESS LOG**”, then press the [SELECT] soft key.



- Press the [▲] or [▼] key to select the station (name or MMSI number) you want to review.

Note: When there is an unread received call, “✉” icon will appear at the head of the station name (or MMSI number).

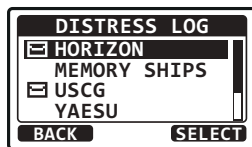

Press the [SELECT] soft key to review details for the selected station.

- Press the [▲] or [▼] key to scroll the display.

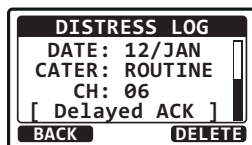
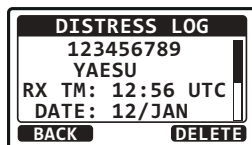

- Press the [BACK] soft key to go back to the DSC distress call list.

10.11.3 Reviewing a Logged Other Calls

The transceiver allows received calls (individual, group, all ships, etc.) to be reviewed.

- [MENU] → “DSC” → “DSC LOG”

- Press the [▲] or [▼] key to select “**OTHER CALL LOG**”, then press the [SELECT] soft key.

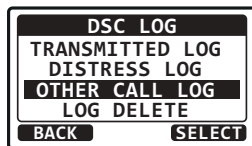

- Press the [▲] or [▼] key to select the station (name or MMSI number) you want to review.

Note: When there is an unread received call, “✉” icon will appear at the head of the station name (or MMSI number).

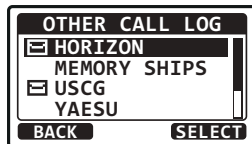

Press the [SELECT] soft key, to review details for the selected station.

- Press the [▲] or [▼] key to scroll the display.

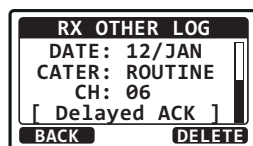
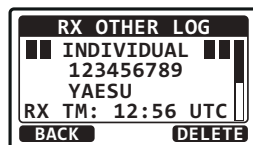

- Press the [BACK] soft key to go back to the DSC other call list.

10.11.4 Deleting Calls from the “DSC LOG” Directory

- [MENU] → “DSC” → “DSC LOG”

- Press the [▲] or [▼] key to select “LOG DELETE”, then press the [SELECT] soft key.



- Press the [▲] or [▼] key to select the category (“TRANSMITTED LOG”, “DISTRESS LOG”, “OTHER CALL LOG”, or “ALL LOG”) to be deleted, then press the [SELECT] soft key.



- Press the [YES] soft key to delete logs of the selected category. (To cancel, press the NO soft key.)



- “Complete” will appear on the display and automatically return to the DSC LOG DELETE list.

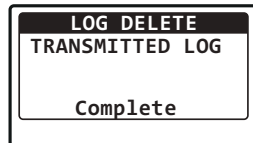

NOTE

The procedure above will delete logged calls of the selected category all at once.

To delete logged calls one by one, review details of a call you want to delete, then press the [DELETE] soft key.

11 SETUP MENU

11.1 DSC SETUP

11.1.1 Individual Directory

The transceiver has a DSC directory that allows you to store a vessel or person's name and the MMSI number associated with vessels you wish to transmit individual calls, position requests and position report transmissions.

To transmit an individual call you must program this directory with information of the persons you wish to call, similar to a cellular phones telephone directory. Refer to section "**10.4.1 Setting up the Individual / Position Call Directory**" for programming.

11.1.2 Individual Reply

This MENU item sets up the radio to automatically (default setting) or manually respond to a DSC individual call requesting you to switch to a working channel for voice communications. When the manual response is selected the MMSI of the calling vessel is shown allowing you to see who is calling. This function is similar to caller id on a cellular phone.

Refer to section "**10.4.2 Setting up Individual Call Reply**" for setting.

11.1.3 Individual Acknowledgement

The radio can be setup to transmit a reply automatically (default) or set so the radio will not reply to an individual call.

Refer to section "**10.4.3 Setting up the Individual Call Acknowledgment**" for setting.

11.1.4 Individual Ringer

The radio can be setup to ring like a telephone to alert you the radio received a DSC individual call. The default setting is 2 minutes, however this can be changed to 15, 10 or 5 seconds.

Refer to section "**10.4.6 Setting up the Individual Call Ringer**" for setting.

11.1.5 Group Directory

For this function to operate, the same group MMSI must be programmed into all the DSC VHF radios within the group of vessels that will be using this feature. To understand group MMSI programming, first a ship MMSI has to be understood. Refer to section "**10.5.1 Setting up a Group Call**" for programming.

11.1.6 Auto Position Polling Call Type

The transceiver has the capability to automatically track four vessels programmed into the individual directory. This selection allows you to select the call type used in the auto position polling.

Refer to section “**10.9.1 Setting up the Polling Call Type**” for setting.

11.1.7 Auto Position Polling Interval Time

The transceiver has the capability to automatically track four vessels programmed into the individual directory. This selection allows you to select time interval between polling call transmissions.

Refer to section “**10.9.2 Setting up the Polling Time Interval**” for setting.

11.1.8 Auto Channel Switching Time

When a DSC distress call or an all ships call (urgency or safety) is received, the transceiver will automatically switch to the channel 16.

This MENU selection allows the automatic switching time to be changed.

1. [MENU] → “SETUP” → “DSC SETUP” → “AUTO CH CHANGE”

2. Press the [▲] or [▼] key to select the desired time, then press the [ENTER] soft key. The switching time can be set to “OFF”, “10 sec”, “30 sec”, “1 min”, “2 min”, “5 min” or “10 min”.

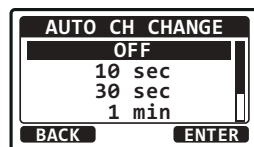

3. Press the [CLR] key to return to radio operation.

11.1.9 DSC Beep

This feature allows the alarm beeps to be turned on (default setting) or off when a DSC call is received. The DSC calls that can be customized are: individual, group, all ships, position request, position report call.

Refer to section “**10.5.4 Setting up the Group Call Ringer**” for setting.

11.2 CHANNEL SETUP

11.2.1 Channel Group (Band Selection)

This selection allows you to change the channel group from International to USA or Canada.

Refer to section “**9.7 CHANNEL GROUP**” for details.

11.2.2 Weather Alert (USA version only)

This selection is used to enable or disable the NOAA Weather Alert function.

1. 

2. Press the [▲] or [▼] key to select “ON” or “OFF”.
3. Press the [ENTER] soft key to store the selected setting.

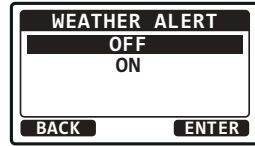

4. Press the [CLR] key to return to radio operation.

11.2.3 Multi Watch

Allows selection of the dual and triple watch functions.

Refer to section “9.9 MULTI WATCH (TO PRIORITY CHANNEL)” for details.

11.2.4 Scan Memory

To be able to scan channels the radio must be programmed. This section allows channels to be stored in scan memory.

Refer to section “9.10.2 Programming Scan Memory” for details.

11.2.5 Scan Type

This selection is used to select the scan mode between “MEMORY SCAN” and “PRIORITY SCAN”.

Refer to section “9.10.1 Selecting the Scan Type” for details.

11.2.6 Scan Resume

This selection is used to select the time the transceiver waits after a transmission ends before the radio start to scan channels again.

1. 

2. Press the [▲] or [▼] key to select the desired resume time.
3. Press the [ENTER] soft key to store the selected setting.

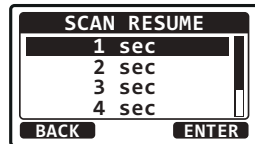

4. Press the [CLR] key to return to radio operation.

11.2.7 Priority Channel

This procedure permits setting a different priority channel to be used when priority scanning. By default, the priority channel is set to Channel 16.

1. [MENU] → "SETUP" → "CHANNEL SETUP" → "PRIORITY CH"

2. Press the [▲] or [▼] key to select the desired channel to be a priority.
3. Press the [ENTER] soft key to store the new setting.
4. Press the [CLR] key to return to radio operation.

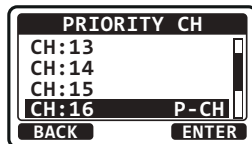

11.2.8 Sub Channel

Allows selection of the sub channel. The default setting is Channel 9.

1. [MENU] → "SETUP" → "CHANNEL SETUP" → "SUB CH"

2. Press the [▲] or [▼] key to select the sub channel.
3. Press the [ENTER] soft key to store the new setting.

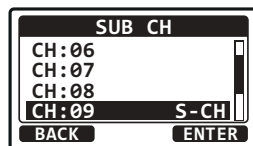

4. Press the [CLR] key to return to radio operation.

11.3 ATIS SETUP (GX1400GPS/E only)

The **GX1400GPS/E** supports the ATIS (Automatic Transmitter Identification System) used in Inland waterways in Europe. When enabled ATIS mode transmits a unique ATIS code each time the PTT switch is released at the end of a transmission.

Users should check with their local marine regulatory authority in their country for assistance in obtaining an ATIS code.

WARNING

The ATIS code can be inputted only once, please be careful not to input the incorrect ATIS code. If the ATIS code need to be reset. Please contact Standard Horizon to obtain the required reset code. Refer to the section "15.6.1 Reset the USER MMSI and ATIS CODE".

11.3.1 ATIS Code Setup (GX1400GPS/E only)

1. [MENU] → "SETUP" → "ATIS SETUP" → "ATIS CODE"

2. Press the [◀] or [▶] key to select the first number of your ATIS, then press the [SELECT] soft key to step to the next number.
3. Repeat step 2 to set your ATIS (ten digits).
4. If a mistake was made entering in the ATIS, press the [▲]/[▼]/[◀]/[▶] key to select "←" or "→", press the [SELECT] soft key until the wrong number is selected, then perform step 2.
5. When finished programming the number, press the [FINISH] soft key. The Radio will ask you to input the ATIS number again. Perform steps 2 through 4 above.
6. After the second number has been input, press the [FINISH] soft key to store the ATIS number in memory.
7. Press the [OK] soft key to return to radio operation.

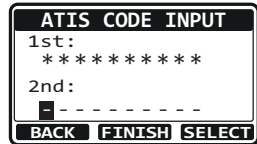
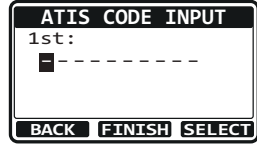

11.3.2 ATIS CH Group

The **GX1400GPS/E** has the capability to turn on and off the ATIS feature for each channel group.

1. [MENU] → "SETUP" → "ATIS SETUP" → "ATIS GROUP"

2. Press the [▲] or [▼] key to select the channel group (International, Canadian*, or USA) you wish to change the setting, and press the [SELECT] soft key. (*: Depending on the region setting.)
3. Press the [▲] or [▼] key to select "ON" or "OFF".

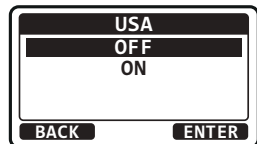
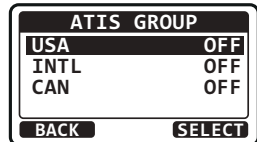

4. Press the [ENTER] soft key to save the store setting.

5. If you want to set the ATIS feature to another channel group, repeat step 2 through .
6. Press the **[CLR]** key to return to radio operation.

NOTE

- The “Scan” and “Dual Watch” features are not available on the channel group while the ATIS feature is turned on.
- The TX output power is set to “1W” automatically on the following channels of the channel group while the ATIS feature is turned on.
CH 06, 08, 10, 11, 12, 13, 14, 15, 17, 71, 72, 74, 75, 76, and 77

11.4 GPS SETUP

11.4.1 Location Format

This menu item selects the coordinate system to be shown on the transceiver series display. The default setting is “ddd°mm.mmm”.

1. **[MENU]** \Rightarrow **“SETUP”** \Rightarrow **“GPS SETUP”** \Rightarrow **“LOCATION FORMAT”**

2. Press the **[▲]** or **[▼]** key to select the desired coordinate system.
3. Press the **[ENTER]** soft key to store the new setting.
4. Press the **[CLR]** key to return to radio operation.

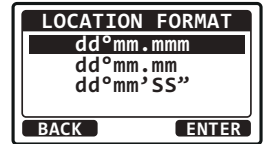

11.4.2 Time Offset

This selection sets the time offset from UTC (time GPS sends to radio). Refer to section “8.8.1 Changing the GPS Time” for details.

11.4.3 Time Area

This selection selects the time area between the local time and the UTC time. Refer to section “8.8.2 Changing the Time Area” for details.

11.4.4 Time Format

This selection selects the time format between the 12-hour system and the 24-hour system.

Refer to section “8.8.3 Changing the Time Format” for details.

11.4.5 Unit Of Measure

This menu item sets the display units of speed, distance and altitude.

1. [MENU] → "SETUP" → "GPS SETUP" → "UNIT OF MEASURE"

2. Press the [▲] or [▼] key to select the item to be set, then press the [SELECT] soft key.

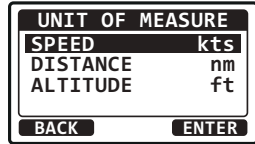

3. Press the [▲] or [▼] key to select the unit.

4. Press the [ENTER] soft key to store the new setting.

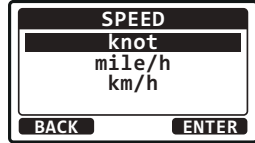

5. Press the [CLR] key to return to radio operation.

11.4.6 Data Speed

This menu is utilized to set the NMEA 0183 baud rate of the GPS input (Yellow and Green wires) and DSC output (White and Brown wires). The default setting is 4800 bps.

When 38400 bps is selected the DSC sentences (DSC & DSE) are output on the White and Brown wires after a DSC distress, position request is received.

1. [MENU] → "SETUP" → "GPS SETUP" → "BAUD RATE"

2. Press the [▲] or [▼] key to select the desired speed from "4800bps" and "38400bps".

3. Press the [ENTER] soft key to save the new setting.

4. Press the [CLR] key to return to radio operation.

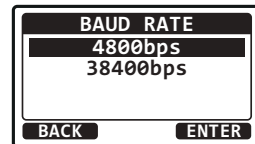

11.4.7 Output Sentences

This selection is utilized to set the NMEA output sentences of the transceiver. By default, the "GLL" and the "RMC" sentences are turned "ON".

1. [MENU] → "SETUP" → "GPS SETUP" → "NMEA OUT"

- Press the [▲] or [▼] key to select the desired sentence type, then press the [SELECT] soft key.
- Press the [▲] or [▼] key to select “ON” or “OFF”.
- Press the [ENTER] soft key to save the new setting.
- Repeat steps 2 through 4 to set the other sentences.
- Press the [CLR] key to return to radio operation.

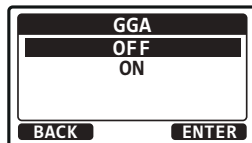
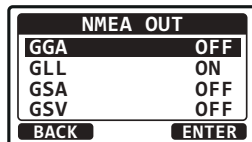

NOTE

- When “UNIT POWER” of “OPTION GPS UNIT” is set to OFF, NMEA sentences will not be output. (OPTION GPS reception data will be output as is.)
- The output interval of each NMEA sentence depends on the output timing on the input device. However, sentences which include POS data will be output at intervals of two seconds or less.
- When all sentences are set to be output, depending on the baud rate, not all sentences can be output at intervals of one second or less. GSA and GSV sentences will be output at intervals of around five seconds.

11.5 CONFIGURATION SETUP

11.5.1 Dimmer Adjustment

Allows adjustment of the backlight intensity or to turn it off.

- [MENU] → “SETUP” → “CONFIGURATION” → “DIMMER”

- Press the [▲] or [▼] key to select the desired level (“5” is default). When “OFF” is selected, the lamp is turned OFF.
- Press the [ENTER] soft key to store the selected level.
- Press the [CLR] key to return to radio operation.

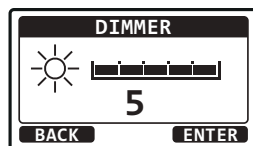

11.5.2 LCD Contrast

This selection sets up the display contract to optimize the viewing angle for the varying mounting locations (overhead or below).

- [MENU] → “SETUP” → “CONFIGURATION” → “CONTRAST”

2. Press the [▲] or [▼] key to select the desired level. The contrast level can be set from “00” to “25”.
3. Press the [ENTER] soft key to store the selected level.
4. Press the [CLR] key to return to radio operation.

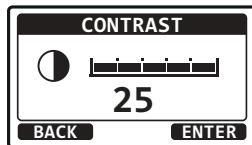

11.5.3 Key Beep

This section allows the level of the key beep to be adjusted or turned off.

1. [MENU] → “SETUP” → “CONFIGURATION” → “KEY BEEP”

2. Press the [▲] or [▼] key to select the desired beep level. The key beep level can be set from “OFF” to “5”.
3. Press the [ENTER] soft key to store the selected level.
4. Press the [CLR] key to return to radio operation.

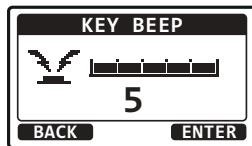

NOTE

Emergency alarm and beeps for DSC operation cannot be turned OFF.

11.5.4 Soft Keys

This MENU item assigns the number of soft keys, soft key selection and how long the display will show the soft key icon after a soft key is pressed.

Assigning Soft Keys

1. [MENU] → “SETUP” → “CONFIGURATION” → “SOFT KEY”

2. Press the [▲] or [▼] key to select “KEY ASSIGNMENT”, then press the [SELECT] soft key.

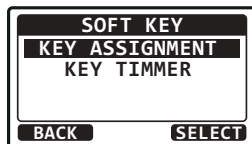

3. Press the [▲] or [▼] key to select the desired soft key number, then press the [SELECT] soft key.

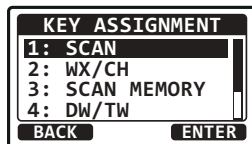

- Press the [▲] or [▼] key to select the desired key function, then press the [ENTER] soft key. Refer to the chart below for available functions.

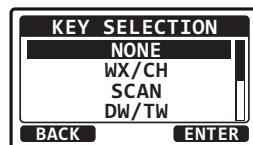

- Repeat steps 3 and 4 to assign up to 6 functions.
- To exit this MENU and return to radio operation press the [BACK] soft key.

Available functions are:

DISPLAY	SOFT KEY ICON	FUNCTION	SOFT KEY NUMBERS ASSIGNED AS DEFAULT
NONE	-	-	-
WX/CH		Switches channels between weather and marine	01 (GX1400GPS, GX1400)
SCAN		Turns the scanning function ON or OFF	05
SCAN MEMORY		Add or remove channels from memory channel scan	04
DW/TW		Starts and stops dual watch or triple watch scan	06
PRESET		Programs or deletes the pre-set memory channel	10 (GX1400GPS, GX1400) 01 (GX1400GPS/E)
TX HI/LO		Selects transmit power	02

Selecting How Long the Soft Keys are Shown

- [MENU] → "SETUP" → "CONFIGURATION" → "SOFT KEY"

- Press the [▲] or [▼] key to select "KEY TIMER", then press the [SELECT] soft key.

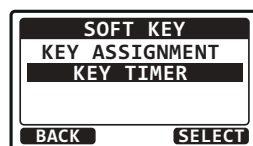

- Press the [▲] or [▼] key to select how long the soft key icon will be shown on the display after a soft key is pressed, then press the [ENTER] soft key.

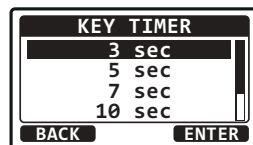

- The showing time can be set to "3 sec", "5 sec", "7 sec", "10 sec", or "15 sec".
- To exit this MENU and return to radio operation press the [BACK] soft key.

11.5.5 Reset

You may reset the memory and settings of the setup categories independently or return the transceiver to the original factory setting.

1. [MENU] → "SETUP" → "CONFIGURATION" → "RESET"

2. Press the [▲] or [▼] key to select the desired category. You can select one from "DSC SETUP", "CH SETUP", "GPS SETUP", "CONFIGURATION", "FACTORY"*1 (all settings except the "MMSI" and "ATIS"*2 will be initialized), "USER MMSI", or "ATIS CODE"*2.

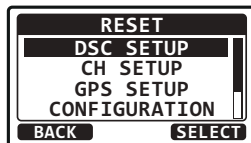

*1 Depending on the radio setting.

*2 GX1400GPS/E only

For details on resetting "USER MMSI" and "ATIS CODE", refer to next section.

3. Press the [SELECT] soft key.

4. Press the [YES] soft key. (To cancel, press the [NO] soft key.)



5. Press the [OK] soft key.

6. Press the [CLR] key to return to radio operation.



11.5.6 Reset the USER MMSI and ATIS CODE

If the MMSI number and ATIS* code (*:GX1400GPS/E only) need to be reset. Please contact Standard Horizon to obtain the required reset codes.

To request the Reset Code

Contact Standard Horizon and confirm the following required information.

- The Information Necessary to obtain the Reset Code
 - Model name
 - Serial number
 - Current MMSI number or/and ATIS code
(To check the MMSI number and ATIS code, refer to "8.6.1 Maritime Mobile Service Identity (MMSI)" or "11.3.1 ATIS Code Setup (GX1400GPS/E only)".)
 - Request codes for the MMSI number or/and the ATIS code
(See "Checking the Request code" below).

- Contact Information

USA/Canada

E-mail: marinetech@yaesu.com

Telephone: (800) 767-2450

Europe

E-mail: service@yaesu.co.uk

Telephone: +44 (0)1962 866667

Other Countries

Contact the dealer or the distributor.

Checking the Request code

1. [MENU] → "SETUP" → "CONFIGURATION" → "RESET"

2. Press the [▲] or [▼] key to select the desired category. You can select one from "USER MMSI", or "ATIS CODE"*, then press the [SELECT] soft key.

*(GX1400GPS/E only)

3. Press the [SELECT] soft key again.
The request code will be displayed.

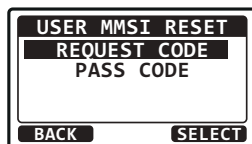
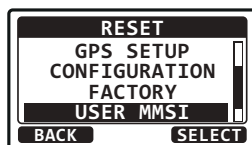

NOTE

When resetting both "USER MMSI" and "ATIS CODE", both request codes are required.

Resetting the USER MMSI and ATIS codes

Here is the procedure for resetting the USER MMSI and ATIS codes after obtaining the reset codes.

1. The RESET screen is displayed on step 2 in "Checking the Request code".

2. Press the [▲] or [▼] key to select "PASSWORD", then press the [SELECT] soft key.

The password input screen will appear.

3. Press the [▲]/[▼]/[◀]/[▶] key to select the first digit of the reset password, then press the [SELECT] soft key to step to the next number.

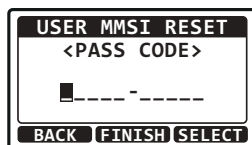
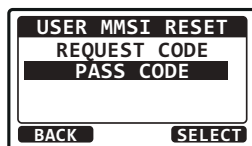

- Repeat steps 3 until the reset password is complete.

If a mistake was made entering in the station name, press the [▲]/[▼]/[◀]/[▶] key to select “←” or “→”, press the [SELECT] soft key until the wrong character is selected, then perform step 3.

- Press the [FINISH] soft key.

If the reset is successful, “COMPLETE” will appear on the screen.

If the error message is displayed, input the reset code again.

- Press the [OK] soft key to return to setup screen.



NOTE

The acquired reset password is available only one time.

12 MAINTENANCE

The inherent quality of the solid-state components used in this transceiver will provide many years of continuous use. Taking the following precautions however, will prevent damage to the transceiver.

- Never key the microphone unless an antenna or suitable dummy load is connected to the transceiver.
- Ensure that the supply voltage to the transceiver does not exceed 16 VDC or fall below 11 VDC.
- Use only STANDARD HORIZON-approved accessories and replacement parts.

In the unlikely event of serious problems, please contact your Dealer or our repair facility.

12.1 REPLACEMENT PARTS

Commonly requested parts, and their part numbers are listed below.

- **Power Cord:** T9025406
- **VOL/SQL Knob (Black):** RA618990A
- **VOL/SQL Knob (White):** RA618980A
- **Mounting Bracket (Black):** RA6208600
- **Mounting Bracket (White):** RA6208500
- **Mounting Bracket Knob (Black):** RA6204100
- **Mounting Bracket Knob (White):** RA6204000
- **Microphone Hanger (Black):** RA0458800
- **Microphone Hanger (White):** RA0436000

12.2 FACTORY SERVICE

In the unlikely event that the radio fails to perform or needs servicing, please contact your dealer.

An "RA" (Return Authorization) number is not necessary to send a product in for service. Include a brief note describing the problem along with your name, return address, phone number, and proof of purchase.

12.3 TROUBLESHOOTING CHART

SYMPTOM	PROBABLE CAUSE	REMEDY
Transceiver fails to power up.	No DC voltage to the transceiver, or blown fuse.	a. Check the 12 VDC battery connections and the fuse. b. The VOL knob needs to be rotated clockwise to turn the radio on.
Transceiver blows fuse when connected to power supply.	Reversed power wires.	Check the power cable for DC voltage, or replace the fuse (6 A 250 V). Make sure the red wire is connected to the positive (+) battery post, and the black wire is connected to the negative (-) battery post. If the fuse still blows, contact your Dealer.
Popping or whining noise from the speaker while engine runs.	Engine noise.	Reroute the DC power cables away from the engine. Add noise suppressor on power cable. Change to resistive spark plug wires and/or add an alternator whine filter.
Sound is not emitted from the internal or external speaker.	Accessory cable.	Check the connections of the accessory cable (Possible short circuit on the External speaker cable WHITE/SHIELD).
Receiving station report low transmit power, even with transceiver set to HI power.	Antenna.	Have the antenna checked or test the transceiver with another antenna. If the problem persists, contact your Dealer for servicing.
"HI BATTERY" or "LO BATTERY" message is appeared when the power is turned on.	The power supply voltage is too high or too low.	Confirm that the connected power supply voltage is between 11 volts and 16.6 volts DC. Confirm that the generator has not malfunctioned.
Your position is not displayed.	Accessory cable.	Check the accessory cable connection. Some GPS use the battery ground line for NMEA connection.
	Setting of the GPS navigation receiver.	Check the output signal format of the GPS navigation receiver. This radio requires NMEA0183 format with GLL, RMC, GGA, or GNS sentence as an output signal. If the GPS has a baud rate setting make sure to select 4800 and parity to NONE.

13 CHANNEL ASSIGNMENTS

13.1 GX1400GPS and GX1400

VHF MARINE CHANNEL CHART							
CH	U	C	I	S/D	TX	RX	CHANNEL USE
01		X	X	D	156.050	160.650	Public Correspondence (Marine Operator)
1001	X			S	156.050		Port Operation and Commercial. VTS in selected areas
02		X	X	D	156.100	160.700	Public Correspondence (Marine Operator)
03		X	X	D	156.150	160.750	Public Correspondence (Marine Operator)
1003	X			S	156.150		U.S. Government Only, Coast Guard
04			X	D	156.200	160.800	Public Correspondence (Marine Operator), Port operation, ship movement
1004		X		S	156.200		Pacific coast: Coast Guard, East Coast: Commercial fishing
05			X	D	156.250	160.850	Public Correspondence (Marine Operator), Port operation, ship movement
1005	X	X		S	156.250		Port operation. VTS in Seattle
06	X	X	X	S	156.300		Inter-ship Safety
07			X	D	156.350	160.950	Public Correspondence (Marine Operator), Port operation, ship movement
1007	X	X		S	156.350		Commercial
08	X	X	X	S	156.400		Commercial (Inter-ship only)
09	X	X	X	S	156.450		Boater Calling channel, Commercial & Non-commercial (Recreational)
10	X	X	X	S	156.500		Commercial
11	X	X	X	S	156.550		Commercial. VTS in selected areas.
12	X	X	X	S	156.600		Port operation. VTS in selected areas.
13	X	X	X	S	156.650		Inter-ship Navigation Safety (Bridge-to-bridge)
14	X	X	X	S	156.700		Port operation. VTS in selected areas.
15	X			S	---	156.750	Environmental (Receive only)
15		X	X	S	156.750		Commercial, non-commercial, ship movement (1 W)
16	X	X	X	S	156.800		International Distress, Safety and Calling
17	X	X	X	S	156.850		State Controlled (1 W)
18			X	D	156.900	161.500	Port operation, ship movement
1018	X	X		S	156.900		Commercial
19			X	D	156.950	161.550	Port operation, ship movement
1019	X	X		S	156.950		Commercial (USA) Coast Guard (Canada)
1019			X	S	156.950		
2019			X	S	161.550		
20	X	X	X	D	157.000	161.600	Canadian Coast Guard Only, International: port operations and shipment
1020			X	S	157.000		
1020	X			S	157.000		Port operation
2020			X	S	161.600		
21			X	D	157.050	161.650	Port operation, ship movement
1021	X	X		S	157.050		U.S. Government Only (USA) Canadian Coast Guard (Canada)
2021		X			---	161.650	CMB Service

VHF MARINE CHANNEL CHART								
CH	U	C	I	S/D	TX		RX	CHANNEL USE
22			X	D	157.100	161.700		Port operation, ship movement
1022	X	X		S	157.100			US Coast Guard Liaison and Maritime Safety Information Broadcasts announced on channel 16 (USA) Canadian Coast Guard Liaison and Maritime Safety Information Broadcasts announced on channel 16 (Canada)
23		X	X	D	157.150	161.750		Public Correspondence (Marine Operator)
1023	X			S	157.150			U.S. Government Only
2023		X			---	161.750		CMB Service
24	X	X	X	D	157.200	161.800		Public Correspondence (Marine Operator)
25	X	X	X	D	157.250	161.850		Public Correspondence (Marine Operator)
2025		X			---	161.850		CMB Service
26	X	X	X	D	157.300	161.900		Public Correspondence (Marine Operator)
27	X	X	X	D	157.350	161.950		Public Correspondence (Marine Operator)
28	X	X	X	D	157.400	162.000		Public Correspondence (Marine Operator)
2028		X			---	162.000		CMB Service
60		X	X	D	156.025	160.625		Public Correspondence (Marine Operator)
61			X	D	156.075	160.675		Public Correspondence (Marine Operator), Port operation, ship movement
1061	X	X		S	156.075			Public Coast: Coast Guard; East Coast: commercial fishing only
62			X	D	156.125	160.725		Public Correspondence (Marine Operator), Port operation, ship movement
1062		X		S	156.125			Public Coast: Coast Guard; East Coast: commercial fishing only
63			X	D	156.175	160.775		Public Correspondence (Marine Operator), Port operation, ship movement
1063	X	X		S	156.175			Port Operation and Commercial. VTS in selected areas.
64		X	X	D	156.225	160.825		Public Correspondence (Marine Operator), Port operation, ship movement
1064	X	X		S	156.225			Public Correspondence (Marine Operator), Port operation, ship movement
65			X	D	156.275	160.875		Public Correspondence (Marine Operator), Port operation, ship movement
1065	X	X		S	156.275			Port Operations
66			X	D	156.325	160.925		Public Correspondence (Marine Operator), Port operation, ship movement
1066	X	X		S	156.325			Port Operations
67	X	X	X	S	156.375			US: Commercial. Used for Bridge-to-bridge communications in lower Mississippi River. Inter-ship only. Canada: Commercial fishing, S&R
68	X	X	X	S	156.425			Non-commercial (Recreational)
69	X	X	X	S	156.475			US: Non-commercial (Recreational), Canada: Commercial fishing only, International: Inter-ship, Port operations and Ship movement
70	X	X	X	S	---	156.525		Digital selective calling (voice communica- tions not allowed)

VHF MARINE CHANNEL CHART								
CH	U	C	I	S/D	TX		RX	CHANNEL USE
71	X	X	X	S	156.575			US, Canada: Non-commercial (Recreational), International: Port operations and Ship movement
72	X	X	X	S	156.625			Non-commercial (Inter-ship only)
73	X	X	X	S	156.675			US: Port Operations, Canada: Commercial fishing only, International: Inter-ship, Port operations and Ship movement
74	X	X	X	S	156.725			US: Port Operations, Canada: Commercial fishing only, International: Inter-ship, Port operations and Ship movement
75	X	X	X	S	156.775			Port Operations (Inter-ship only) (1 W)
76	X	X	X	S	156.825			Port Operations (Inter-ship only) (1 W)
77	X	X		S	156.875			Port Operations (Inter-ship only) (1 W)
77			X	S	156.875			Port Operations (Inter-ship only)
78			X	D	156.925	161.525		Public Correspondence (Marine Operator), Port operation, ship-movement
1078	X	X		S	156.925			Non-commercial (Recreational)
1078			X	S	156.925			Port operation and Ship movement
2078			X	S	161.525			
79			X	D	156.975	161.575		Port operation and Ship movement
1079	X	X		S	156.975			Commercial
1079			X	S	156.975			Port operation and Ship movement
2079			X	S	161.575			
80			X	D	157.025	161.625		Port operation, ship movement
1080	X	X		S	157.025			Commercial
81			X	D	157.075	161.675		Port operation, ship movement
1081	X	X		S	157.075			U.S. Government Only - Environmental protection operations. (USA) Canadian Coast Guard Only (Canada)
82			X	D	157.125	161.725		Public Correspondence (Marine Operator), Port operation, ship movement
1082	X	X		S	157.125			U.S. Government Only (USA) Canadian Coast Guard Only (Canada)
83			X	D	157.175	161.775		Public Correspondence (Marine Operator)
1083	X	X		S	157.175			U.S. Government Only (USA) Canadian Coast Guard Only (Canada)
2083		X			---	161.775		CMB Service
84	X	X	X	D	157.225	161.825		Public Correspondence (Marine Operator)
85	X	X	X	D	157.275	161.875		Public Correspondence (Marine Operator)
86	X	X	X	D	157.325	161.925		Public Correspondence (Marine Operator)
87	X	X	X	S	157.375			Port operation, ship movement
88	X	X	X	S	157.425			Port operation, ship movement Commercial, Inter-ship Only

NOTE: Simplex channels, 1003, 1021, 1023, 1061, 1064, 1081, 1082 and 1083 CANNOT be lawfully used by the general public in U.S.A. waters.

13.2 GX1400GPS/E

CH	TX (MHz)	RX (MHz)	SIMPLEX/DUPLEX	LOW PWR	CHANNEL USE	
					All countries (except Germany)	Germany
01	156.050	160.650	DUPLEX	–	TELEPHONE	NAUTIK
02	156.100	160.700	DUPLEX	–	TELEPHONE	NAUTIK
03	156.150	160.750	DUPLEX	–	TELEPHONE	NAUTIK
04	156.200	160.800	DUPLEX	–	INTL	NAUTIK
05	156.250	160.850	DUPLEX	–	INTL	NAUTIK
06	156.300		SIMPLEX	LOW*4	SAFETY	SHIP-SHIP
07	156.350	160.950	DUPLEX	–	INTL	NAUTIK
08	156.400		SIMPLEX	LOW*4	COMMERCIAL	SHIP-SHIP
09	156.450		SIMPLEX	–	CALLING	NAUTIK
10	156.500		SIMPLEX	LOW*4	COMMERCIAL	SHIP-SHIP
11	156.550		SIMPLEX	LOW*4	VTS	SHIP-PORT
12	156.600		SIMPLEX	LOW*4	VTS	SHIP-PORT
13	156.650		SIMPLEX	LOW*4	BRG/BRG	SHIP-SHIP
14	156.700		SIMPLEX	LOW*4	VTS	SHIP-PORT
15	156.750		SIMPLEX	LOW	COMMERCIAL	ON-BOARD
16	156.800		SIMPLEX	–	DISTRESS	
17	156.850		SIMPLEX	LOW	SAR	ON-BOARD
18	156.900	161.500	DUPLEX	–	INTL	NAUTIK
19	156.950	161.550	DUPLEX	–	INTL	NAUTIK
1019	156.950		SIMPLEX	–	–	–
2019	161.550		SIMPLEX	–	–	–
20	157.000	161.600	DUPLEX	LOW*6	PORT OPR	NAUTIK
1020	157.000		SIMPLEX	–	–	–
2020	161.600		SIMPLEX	–	–	–
21	157.050	161.650	DUPLEX	–	INTL	NAUTIK
22	157.100	161.700	DUPLEX	–	INTL	NAUTIK
23	157.150	161.750	DUPLEX	–	INTL	
24	157.200	161.800	DUPLEX	–	TELEPHONE	
25	157.250	161.850	DUPLEX	–	TELEPHONE	
26	157.300	161.900	DUPLEX	–	TELEPHONE	
27	157.350	161.950	DUPLEX	–	TELEPHONE	
28	157.400	162.000	DUPLEX	–	TELEPHONE	
31*1	157.550	162.150	DUPLEX	LOW	NED JACH- THAV	–
37*2	157.850		SIMPLEX	LOW	YACHTING UK	–
60	156.025	160.625	DUPLEX	–	TELEPHONE	NAUTIK
61	156.075	160.675	DUPLEX	–	INTL	NAUTIK
62	156.125	160.725	DUPLEX	–	INTL	NAUTIK
63	156.175	160.775	DUPLEX	–	INTL	NAUTIK
64	156.225	160.825	DUPLEX	–	TELEPHONE	NAUTIK
65	156.275	160.875	DUPLEX	–	INTL	NAUTIK
66	156.325	160.925	DUPLEX	–	INTL	NAUTIK
67	156.375		SIMPLEX	–	BRG/BRG	NAUTIK
68	156.425		SIMPLEX	–	SHIP-SHIP	
69	156.475		SIMPLEX	–	PLEASURE	
70	–	156.525	SIMPLEX	–	DSC	
71	156.575		SIMPLEX	LOW*4	PLEASURE	SHIP-PORT
72	156.625		SIMPLEX	LOW*4	SHIP-SHIP	
73	156.675		SIMPLEX	–	PORT OPR	NAUTIK
74	156.725		SIMPLEX	LOW*4	PORT OPR	SHIP-PORT
75	156.775		SIMPLEX	LOW	–	SHIP-PORT

CH	TX (MHz)	RX (MHz)	SIMPLEX/DUPLEX	LOW PWR	CHANNEL USE	
					All countries (except Germany)	Germany
76	156.825		SIMPLEX	LOW	–	NAUTIK
77	156.875		SIMPLEX	LOW*4	PORT OPR	SHIP-SHIP
78	156.925	161.525	DUPLEX	–	INTL	NAUTIK
1078	156.925		SIMPLEX	–	–	–
2078	161.525		SIMPLEX	–	–	–
79	156.975	161.575	DUPLEX	–	INTL	NAUTIK
1079	156.975		SIMPLEX	–	–	–
2079	161.575		SIMPLEX	–	–	–
80	157.025	161.625	DUPLEX	–	INTL	NAUTIK
81	157.075	161.675	DUPLEX	–	INTL	NAUTIK
82	157.125	161.725	DUPLEX	–	INTL	TELEPHONE
83	157.175	161.775	DUPLEX	–	INTL	TELEPHONE
84	157.225	161.825	DUPLEX	–	TELEPHONE	
85	157.275	161.875	DUPLEX	–	TELEPHONE	
86	157.325	161.925	DUPLEX	–	TELEPHONE	
87	157.375		SIMPLEX	–	PORT OPR	
88	157.425		SIMPLEX	–	PORT OPR	
M*3	157.850		SIMPLEX	–	YACHTING UK	–
M2*3	161.425		SIMPLEX	–	YACHTING UK	–
L1*5	155.500		SIMPLEX	–	PLEASURE	–
L2*5	155.525		SIMPLEX	–	PLEASURE	–
L3*5	155.650		SIMPLEX	–	PLEASURE	–
F1*5	155.625		SIMPLEX	–	FISHING	–
F2*5	155.775		SIMPLEX	–	FISHING	–
F3*5	155.825		SIMPLEX	–	FISHING	–

NOTE: Country Channel assignment are different depending on the region.

*1: Channel 31 is assigned to only BELGIUM and NETHERLAND.

*2: Channel 37 is assigned to only NETHERLAND.

*3: Channel M and M2 are assigned to only UNITED KINGDOM.

*4: LOW Power setting for BELGIUM, NETHERLAND and GERMANY.

*5: Channel L1, L2, L3, F1, F2 and F3 are assigned to only SWEDEN.

*6: LOW Power setting for GERMANY.

14 SPECIFICATIONS

Performance specifications are nominal, unless otherwise indicated, and are subject to change without notice. Measured in accordance with TIA/EIA-603.

●GENERAL

Channels	All USA, International and Canadian
Normal Input Voltage	13.8 VDC \pm 20%
Current Drain	
Standby	0.3 A
Receive (at Maximum AF Output)	1.2 A
Transmit	5.0 A (Hi); 1.0 A (Lo)
DSC Transmitted Call Log	30
DSC Distress Call Log	30
DSC Received Call Log	50
Individual Directory	60
Group Directory	30
Display Type	2.6" x 1.4" (55 x 31 mm) Full Dot Matrix (102 x 56 pixels)
Dimensions (W x H x D)	6.14" x 2.40" x 3.94" (156 x 61 x 100 mm)
Flush-Mount Dimensions (W x H x D) ...	5.16" x 1.97" x 4.72" (131 x 50 x 120 mm)
Weight	1.76 lbs (800 g)

●TRANSMITTER

Frequency Range	156.025 MHz to 161.600 MHz (Inter National)
RF Output	25 W (Hi); 1 W (Lo)
Conducted Spurious Emissions	Less than -80 dB (Hi); -66 dB (Lo)
Audio Response	within +1/-3 of a 6 dB/octave pre-emphasis characteristic at 300 to 3000 Hz
Audio Distortion	Less than 5 %
Modulation	16K0G3E (for Voice), 16K0G2B (for DSC)
Frequency Stability	\pm 0.0003 % (-4°F to +140°F (-20°C to +60°C))
FM Hum and Noise	50 dB

●RECEIVER

Frequency Range	156.050 to 163.275 MHz
Sensitivity	
20 dB Quieting	0.30 μ V
12 dB SINAD	0.25 μ V
Squelch Sensitivity (Threshold)	0.13 μ V
Modulation Acceptance Bandwidth	\pm 7.5 kHz

Selectivity (Typical)

Spurious and Image Rejection	75 dB for Voice (70 dB for DSC)
Intermodulation and Rejection	70 dB for Voice (70 dB for DSC)
Audio Output	4.5 W (at 4 ohms external speaker output)
Audio Response	within + 1/-3 of a 6 dB/octave de-emphasis characteristic at 300 to 3000 Hz
Frequency Stability (-4°F to +140°F (-20°C to +60°C)).....	±0.0003 %
Channel Spacing	25 kHz
DSC Format	ITU-R M.493-13 (European version: Meets ITU-R M493-14)

● **INTERNAL GPS RECEIVER (GX1400GPS and GX1400GPS/E only)**

Receiver Channels	66 Channels
Sensitivity	Less than -147 dBm
Time to First Fix	1 minute typical (@Cold Start) 5 seconds typical (@ Hot Start)
Geodetic Datum	WGS84

NMEA 0183 INPUT/OUTPUT Sentences

4800 Baud selected:

NMEA 0183 Input (4800 baud)	GGA, GLL, GNS, RMC, GSA, & GSV
NMEA 0183 Output (4800 baud)	DSC, DSE, GGA*, GLL*, GNS*, RMC*, GSA* & GSV*

38400 Baud selected:

NMEA 0183-HS Input (38400 baud) ...	GGA, GLL, GNS, RMC, GSA, & GSV
NMEA 0183-HS Output (38400 baud)	DSC, DSE, GGA*, GLL*, GNS*, RMC*, GSA* & GSV*

*(GX1400GPS and GX1400GPS/E only)

14.1 GX1400 DIMENSIONS

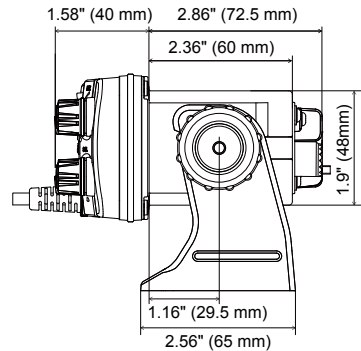
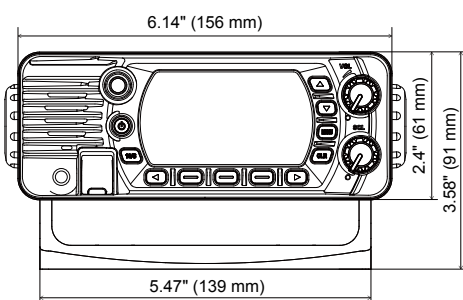
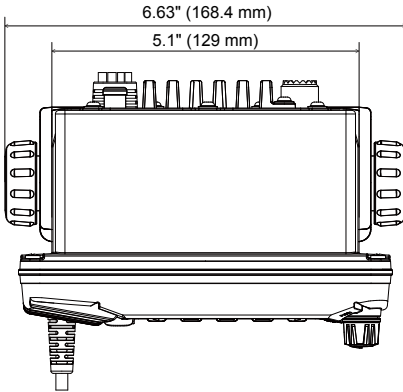
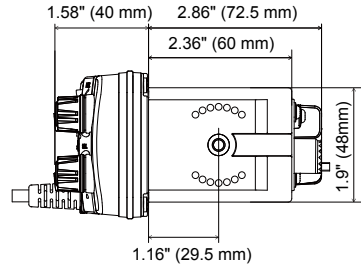
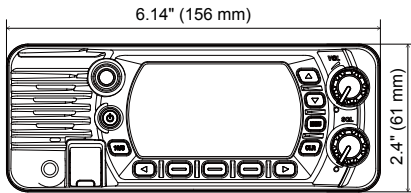
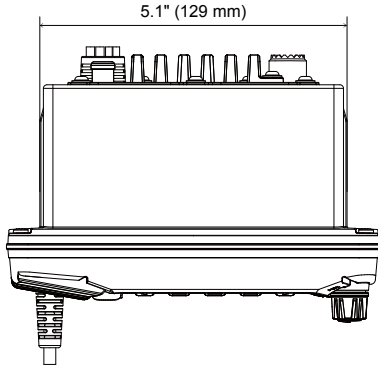

15 FCC RADIO LICENSE INFORMATION

Standard Horizon radios comply with the Federal Communication Commission (FCC) requirements that regulate the Maritime Radio Service.

15.1 STATION LICENSE

An FCC ship station license is no longer required for any vessel traveling in U.S. waters (except Hawaii) which is under 20 meters in length. However, any vessel required to carry a marine radio on an international voyage, carrying a HF single side band radiotelephone or marine satellite terminal is required to have a ship station license. FCC license forms, including applications for ship (605) and land station licenses can be downloaded via the Internet at <http://www.fcc.gov/Forms/Form605/605.html>. To obtain a form from the FCC, call (888) 225-5322.

15.2 RADIO CALL SIGN

Currently the FCC does not require recreational boaters to have a Ship Radio Station License. The USCG recommends the boats registration number and the state to be used when calling another vessel.

15.3 CANADIAN SHIP STATION LICENSING

Please click on the following link for licensing information:

http://www.ic.gc.ca/eic/site/smt-gst.nsf/eng/h_sf01775.html

The following link lists several Branches/Offices regarding licensing. Licensing depends on the region of operations.

<http://www.ic.gc.ca/eic/site/smt-gst.nsf/eng/sf01742.html>

15.4 FCC / IC INFORMATION

The following data pertaining to the transceiver is necessary to fill out the license application.

FCC Type Accepted FCC Part 80
IC Type Accepted RSS-182
Output Power 1 Watt (low) and 25 Watts (high)
Emission 16K0G3E, 16K0G2B
Frequency Range 156.025 to 163.275 MHz
FCC ID K6630653X3D
IC 511B-30653X3D

16 FCC NOTICE

NOTICE

Unauthorized changes or modifications to this equipment may void compliance with FCC Rules. Any change or modification must be approved in writing by STANDARD HORIZON.

NOTICE

This equipment has been tested and found to comply with the limits for a Class B digital device, pursuant to Part 15 of the FCC Rules. These limits are designed to provide reasonable protection against harmful interference in a residential installation. This equipment generates, uses and can radiate radio frequency energy and, if not installed and used in accordance with the instructions, may cause harmful interference to radio communications. However, there is no guarantee that interference will not occur in a particular installation. If this equipment does cause harmful interference to radio or television reception, which can be determined by turning the equipment off and on, the user is encouraged to try to correct the interference by one or more of the following measures:

- Reorient or relocate the receiving antenna.
- Increase the separation between the equipment and receiver.
- Connect the equipment into an outlet on a circuit different from that to which the receiver is connected.
- Consult the dealer or an experienced radio/TV technician for help.

WARNING

It is a violation of the rules of the Federal Communications Commission to input an MMSI that has not been properly assigned to the end user, or to otherwise input any inaccurate data in this device.

THIS DEVICE COMPLIES WITH PART 15 OF THE FCC RULES. OPERATION IS SUBJECT TO THE FOLLOWING TWO CONDITIONS: (1) THIS DEVICE MAY NOT CAUSE HARMFUL INTERFERENCE, AND (2) THIS DEVICE MUST ACCEPT ANY INTERFERENCE RECEIVED, INCLUDING INTERFERENCE THAT MAY CAUSE UNDESIRE OPERATION.

Changes or modifications to this device not expressly approved by YAESU U.S.A. could void the User's authorization to operate this device.

This device complies with Industry Canada license-exempt RSS standard(s). Operation is subject to the following two conditions: (1) this device may not cause interference, and (2) this device must accept any interference, including interference that may cause undesired operation of the device.

Le présent appareil est conforme aux CNR d'Industrie Canada applicables aux appareils radio exempts de licence. L'exploitation est autorisée aux deux conditions suivantes : (1) l'appareil ne doit pas produire de brouillage, et (2) l'utilisateur de l'appareil doit accepter tout brouillage radioélectrique subi, même si le brouillage est susceptible d'en compromettre le fonctionnement.

Under Industry Canada regulations, this radio transmitter may only operate using an antenna of a type and maximum (or lesser) gain approved for the transmitter by Industry Canada. To reduce potential radio interference to other users, the antenna type and its gain should be so chosen that the equivalent isotropically radiated power (e.i.r.p.) is not more than that necessary for successful communication.

Conformément à la réglementation d'Industrie Canada, le présent émetteur radio peut fonctionner avec une antenne d'un type et d'un gain maximal (ou inférieur) approuvé pour l'émetteur par Industrie Canada. Dans le but de réduire les risques de brouillage radioélectrique à l'intention des autres utilisateurs, il faut choisir le type d'antenne et son gain de sorte que la puissance isotrope rayonnée équivalente (p.i.r.e.) ne dépasse pas l'intensité nécessaire à l'établissement d'une communication satisfaisante.

STANDARD HORIZON Limited Warranty

Limited Warranty is valid only in the country/region where this product was originally purchased.

On-line Warranty Registration:

Thank you for buying STANDARD HORIZON products! We are confident your new radio will serve your needs for many years! Please register your product at www.standardhorizon.com - Owner's Corner

Warranty Terms:

Subject to the Limitations of the Warranty and the Warranty Procedures described below, YAESU MUSEN hereby warrants this product to be free of defects in materials and workmanship in normal use during the "Warranty Period." (the "Limited Warranty").

Limitations of Warranty:

- A. YAESU MUSEN is not liable for any express warranties except the Limited Warranty described above.
- B. The Limited Warranty is extended only to the original end-use purchaser or the person receiving this product as a gift, and shall not be extended to any other person or transferee.
- C. Unless a different warranty period is stated with this YAESU product, the Warranty Period is three years from the date of retail purchase by the original end-use purchaser.
- D. The Limited Warranty is valid only in the country/region where this product was originally purchased.
- E. During the Warranty Period, YAESU MUSEN will, at its sole option, repair or replace (using new or refurbished replacement parts) any defective parts within a reasonable period of time and free of charge.
- F. The Limited Warranty does not cover shipping cost (including transportation and insurance) from you to us, or any import fees, duties or taxes.
- G. The Limited Warranty does not cover any impairment caused by tampering, misuse, failure to follow instructions supplied with the product, unauthorized modifications, or damage to this product for any reasons, such as: accident; excess moisture; lightning; power surges; connection to improper voltage supply; damage caused by inadequate packing or shipping procedures; loss of, damage to or corruption of stored data; product modification to enable operation in another country/purpose other than the country/purpose for which it was designed, manufactured, approved and/or authorized; or the repair of products damaged by these modifications.
- H. The Limited Warranty applies only to the product as it existed at the time of the original purchase, by the original retail purchaser, and shall not preclude YAESU MUSEN from later making any changes in design, adding to, or otherwise improving subsequent versions of this product, or impose upon YAESU MUSEN any obligation to modify or alter this product to conform to such changes, or improvements.
- I. YAESU MUSEN assumes no responsibility for any consequential damages caused by, or arising out of, any such defect in materials or workmanship.
- J. TO THE FULLEST EXTENT PERMITTED BY LAW, YAESU MUSEN SHALL NOT BE RESPONSIBLE FOR ANY IMPLIED WARRANTY WITH RESPECT TO THIS PRODUCT.
- K. If the original retail purchaser timely complies with the Warranty Procedures described below, and YAESU MUSEN elects to send the purchaser a replacement product rather than repair the "original product", then the Limited Warranty shall apply to the replacement product only for the remainder of the original product Warranty Period.
- L. Warranty statutes vary from state to state, or country to country, so some of the above limitations may not apply to your location.

Warranty Procedures:

1. To find the Authorized STANDARD HORIZON Service Center in your country/region, visit www.standardhorizon.com. Contact the STANDARD HORIZON Service Center for specific return and shipping instructions, or contact an authorized STANDARD HORIZON dealer/distributor from whom the product was originally purchased.
2. Include proof of original purchase from an authorized STANDARD HORIZON dealer/distributor, and ship the product, freight prepaid, to the address provided by the STANDARD HORIZON Service Center in your country/region.
3. Upon receipt of this product, returned in accordance with the procedures described above, by the STANDARD HORIZON Authorized Service Center, all reasonable efforts will be expended by YAESU MUSEN to cause this product to conform to its original specifications. YAESU MUSEN will return the repaired product (or a replacement product) free of charge to the original purchaser. The decision to repair or replace this product is the sole discretion of YAESU MUSEN.

Other conditions:

YAESU MUSEN'S MAXIMUM LIABILITY SHALL NOT EXCEED THE ACTUAL PURCHASE PRICE PAID FOR THE PRODUCT. IN NO EVENT SHALL YAESU MUSEN BE LIABLE FOR LOSS OF, DAMAGE TO OR CORRUPTION OF STORED DATA, OR FOR SPECIAL, INCIDENTAL, CONSEQUENTIAL, OR INDIRECT DAMAGES, HOW EVER CAUSED; INCLUDING WITHOUT LIMITATION TO THE REPLACEMENT OF EQUIPMENT AND PROPERTY, AND ANY COSTS OF RECOVERING, PROGRAMMING OR REPRODUCING ANY PROGRAM OR DATA STORED IN OR USED WITH THE YAESU PRODUCT.

Some Countries in Europe and some States of the USA do not allow the exclusion or limitation of incidental or consequential damages, or a limitation on how long an implied warranty lasts, so the above limitation or exclusions may not apply. This warranty provides specific rights, there may be other rights available which may vary between countries in Europe or from state to state within the USA.

This Limited Warranty is void if the label bearing the serial number has been removed or defaced.

cut here

TEMPLATE for the GX1400 Series

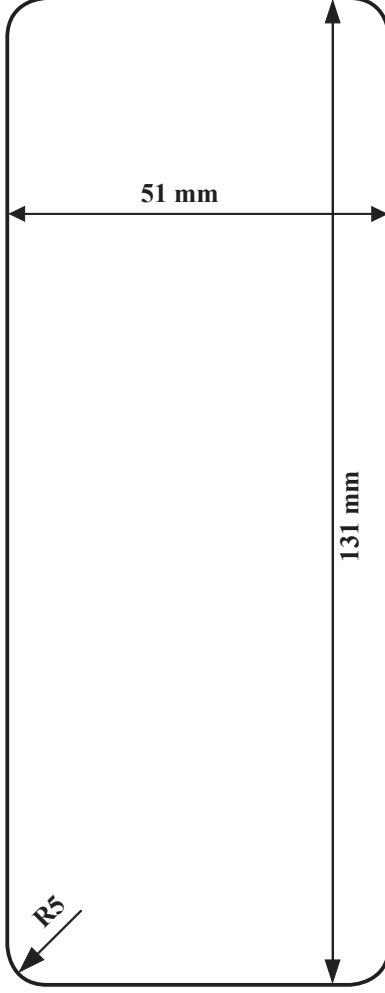

Use this template to mark the location where the rectangular hole for the flush mount is to be cut.

EU Declaration of Conformity

We, Yaesu Musen Co. Ltd of Tokyo, Japan, hereby declare that this radio equipment GX1400GPS/E is in full compliance with EU Radio Equipment Directive 2014/53/EU. The full text of the Declaration of Conformity for this product is available to view at :// www.yaesu.com/jp/red

ATTENTION – Conditions of usage

This transceiver works on frequencies that are regulated and not permitted to be used without authorisation in the EU countries shown in this table. Users of this equipment should check with their local spectrum management authority for licensing conditions applicable for this equipment.

					
AT	BE	BG	CY	CZ	DE
DK	ES	EE	FI	FR	UK
GR	HR	HU	IE	IT	LT
LU	LV	MT	NL	PL	PT
RO	SK	SI	SE	CH	IS
LI	NO	–	–	–	–

Disposal of Electronic and Electrical Equipment

Products with the symbol (crossed-out wheeled bin) cannot be disposed as household waste.

Electronic and Electrical Equipment should be recycled at a facility capable of handling these items and their waste by-products.

Please contact a local equipment supplier representative or service center for information about the waste collection system in your country.



STANDARD HORIZON

Nothing takes to water like Standard Horizon

Copyright 2019
YAESU MUSEN CO., LTD.
All rights reserved.

No portion of this manual may be
reproduced without the permission of
YAESU MUSEN CO., LTD.

YAESU MUSEN CO., LTD.

Tennozu Parkside Building
2-5-8 Higashi-Shinagawa, Shinagawa-ku, Tokyo 140-0002 Japan

YAESU USA

6125 Phyllis Drive, Cypress, CA 90630, U.S.A.

YAESU UK

Unit 12, Sun Valley Business Park, Winnall Close
Winchester, Hampshire, SO23 0LB, U.K.

1905D-CC

Printed in China



E M O 6 5 N 2 0 1