

FURUNO

OPERATOR'S MANUAL

INTERFACE UNIT

MODEL **IF-NMEASC**



IMPORTANT NOTICES



- This manual is intended for use by readers with a solid knowledge of English.
- No part of this manual may be copied or reproduced without written permission.
- If this manual is lost or worn, contact your dealer about replacement.
- The contents of this manual and equipment specifications are subject to change without notice.
- Store this manual in a convenient place for future reference.
- FURUNO will assume no responsibility for the damage caused by improper use or modification of the equipment (including software) by an unauthorized agent or a third party.
- When it is time to discard this product it must be done according to local regulations for disposal of industrial waste. For disposal in the USA, refer to the Electronics Industries Alliance (<http://www.eiae.org/>).









SAFETY INSTRUCTIONS



The operator and installer must read the applicable safety instructions before attempting to install or operate the equipment.

 WARNING	Indicates a potentially hazardous situation which, if not avoided, could result in death or serious injury.
 CAUTION	Indicates a potentially hazardous situation which, if not avoided, can result in minor or moderate injury.







 Warning, Caution	 Prohibitive Action	 Mandatory Action
--	--	--



Safety instructions for the operator

 WARNING	
	Do not open the equipment. Only qualified personnel should work inside the equipment.
	Do not disassemble or modify the equipment. Fire, electrical shock or serious injury can result.
	Immediately turn off the power at the power source if <ul style="list-style-type: none"> - water leaks into the equipment - something is dropped into the equipment - the equipment is emitting smoke or is on fire - the equipment is emitting strange noises Continued use of the equipment can cause fire or electrical shock. Contact a FURUNO dealer or agent for service.
	Do not operate the equipment with wet hands. Electrical shock can result.
	Use the proper fuse. Use of the wrong fuse can cause fire or electrical shock.

 WARNING	
	Do not place liquid-filled containers on the top of the equipment. Fire or electrical shock can result if a liquid spills into the equipment.
	Make sure no rain or water splash leaks into the equipment. Fire or electrical shock can result if water leaks into the equipment.

Safety instructions for the installer

 WARNING	
	<p>Turn off the power at the switchboard before beginning the installation.</p> <p>Fire or electrical shock can result if the power is left on.</p>
	<p>Do not install the equipment where it may get wet from rain or water splash.</p> <p>Water in the equipment can result in fire, electrical shock or damage to the equipment.</p>
	<p>Be sure that the power supply is compatible with the voltage rating of the equipment.</p> <p>Connecting an incompatible power supply can cause fire or damage the equipment. The voltage rating appears on the inlet of power.</p>
	<p>Do not connect this unit to NMEA 2000 bus.</p> <p>It is intended for one-to-one connection with the SC-30. Connection to an NMEA 2000 bus can result in network trouble and, in the worst case, fire.</p>
	<p>Do not open the equipment.</p> <p>Only qualified personnel should work inside the equipment.</p>

 CAUTION		
	<p>Observe the following compass safe distances to prevent interference to a magnetic compass:</p>	
	Standard compass	Steering compass
IF-NMEASC	1.05 m	0.70 m

Warning labels are attached to the equipment. Do not remove these labels. If a label is missing or illegible, contact a FURUNO agent or dealer about replacement.

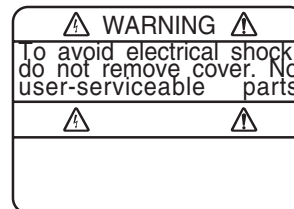

Name: Warning Label (1)
Type: 86-003-1011-1
Code No.: 100-236-231

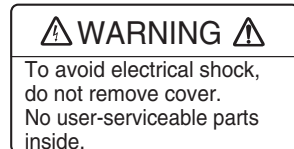

Name: Warning Label (2)
Type: 86-129-1001-1
Code No.: 100-236-741

TABLE OF CONTENTS

FOREWORD	v
SYSTEM CONFIGURATION	vi
1. MOUNTING	1
1.1 Equipment List	1
1.2 Mounting Procedure	1
2. WIRING	2
3. ADJUSTMENTS	4
3.1 LEDs and Equipment Status	4
3.2 Setting Up NMEA Ports	5
3.3 Heading, Pitch and Roll Offsets	8
4. OPERATION	9
5. MAINTENANCE, TROUBLESHOOTING	10
5.1 Preventive Maintenance	10
5.2 Replacing the Fuse	11
5.3 Troubleshooting	11
5.4 Self Test	12
5.5 Memory Clear	13
SPECIFICATIONS	SP-1
OUTLINE DRAWING	D-1
INTERCONNECTION DIAGRAM	S-1

FOREWORD

A Word to the Owner of the IF-NMEASC

Congratulations on your choice of the FURUNO IF-NMEASC Interface Unit. We are confident you will see why the FURUNO name has become synonymous with quality and reliability.

For 60 years FURUNO Electric Company has enjoyed an enviable reputation for quality marine electronics equipment. This dedication to excellence is furthered by our extensive global network of agents and dealers.

This equipment is designed and constructed to meet the rigorous demands of the marine environment. However, no machine can perform its intended function unless installed, operated and maintained properly. Please carefully read and follow the recommended procedures for installation, operation and maintenance.

Thank you for considering and purchasing FURUNO equipment.

Features

The IF-NMEASC is a dedicated interface unit for the SC-30 Satellite Compass. It receives NMEA 2000^{®*} format heading, pitch, roll and GPS position data from the SC-30, converts them to NMEA 0183 format data and outputs the converted data to external equipment.

- Input port: One NMEA 2000 format port
- Four output ports: NMEA 0183x2, AD-10x1, Analog (pitch and roll)x1
- Offsets for heading, pitch and roll

*: NMEA 2000 is a registered trademark of the National Marine Electronics Association USA.

SYSTEM CONFIGURATION

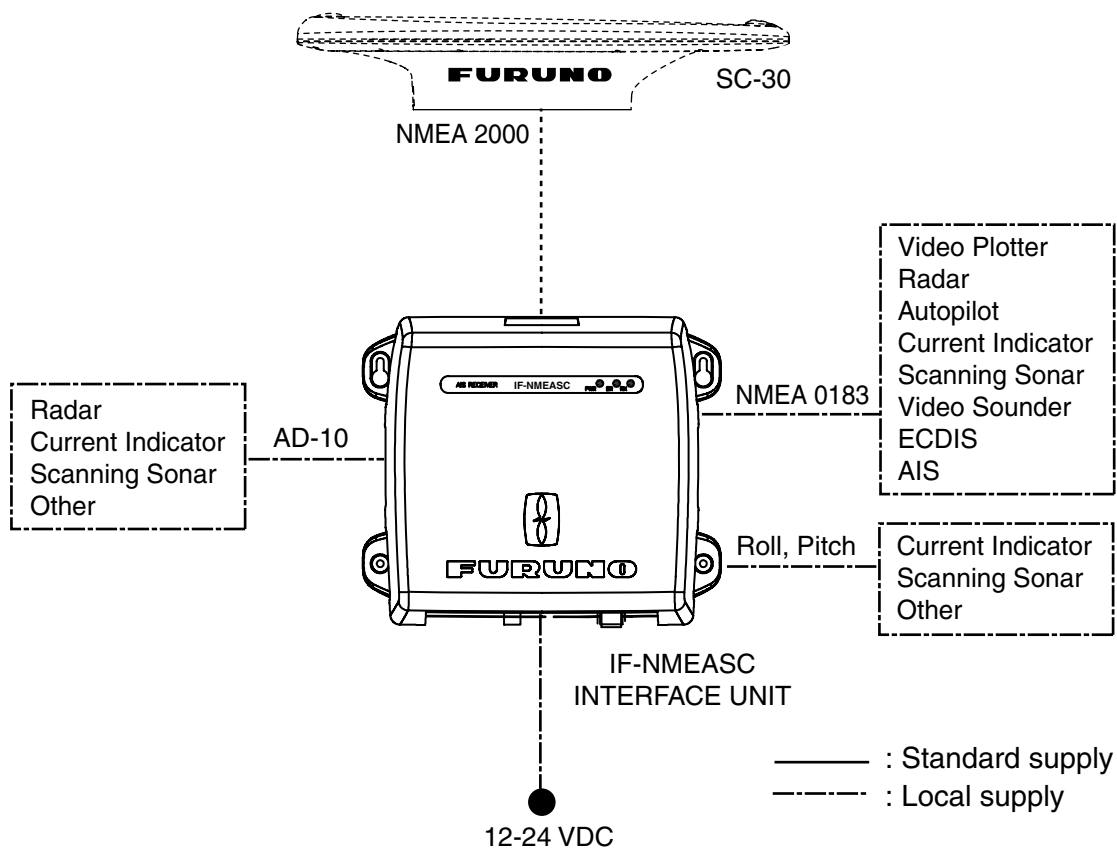

1. MOUNTING

1.1 Equipment List

Name	Type	Code No.	Qty	Remarks
Interface Unit	IF-NMEASC	-	1	
Installation Materials	CP20-03001	001-023-400	1 set	<ul style="list-style-type: none"> • Cable ties (CN-150N, 12 pcs.) • Self-tapping screws (φ3x10, 4 pcs.)
Spare Parts	SP20-01301	001-019-800	1 set	Fuse FGMB 125V 2A (3 pcs.)

1.2 Mounting Procedure

When choosing a mounting location for the unit, keep the following points in mind:

- Select a location where shock and vibration are minimal.
- Locate the unit away from places subject to rain or water splash.
- Keep the unit away from exhaust pipes and vents.
- Locate the unit out of direct sunlight because of heat that can build up inside its cabinet.
- The location should be well ventilated.
- Observe the maintenance space mentioned in the outline drawing at the back of this manual and the compass safe distances in the safety instructions.
- Fix the unit with four φ3x10 self-tapping screws (supplied).

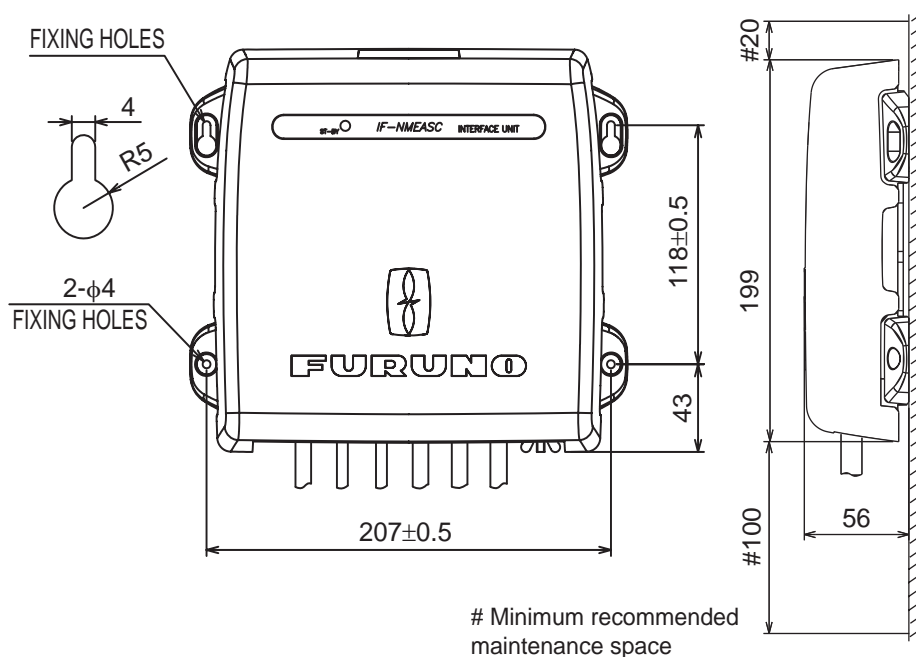

2. WIRING

Open the IF unit with your hands, detach the shield cover and connect external equipment, referring to the illustration below and the interconnection diagram. Cables are mainly connected to the unit with WAGO connectors. See the instructions below for how to attach wiring to the connectors. The opener for the WAGO connectors is attached to the inside of the inner cover. Fix cables to their respective cable posts with cable ties (supplied). Run a ground wire (IV-2.0sq., local supply) between the ground terminal and ship's grounding bus. Supply power from breaker on mains switchboard.

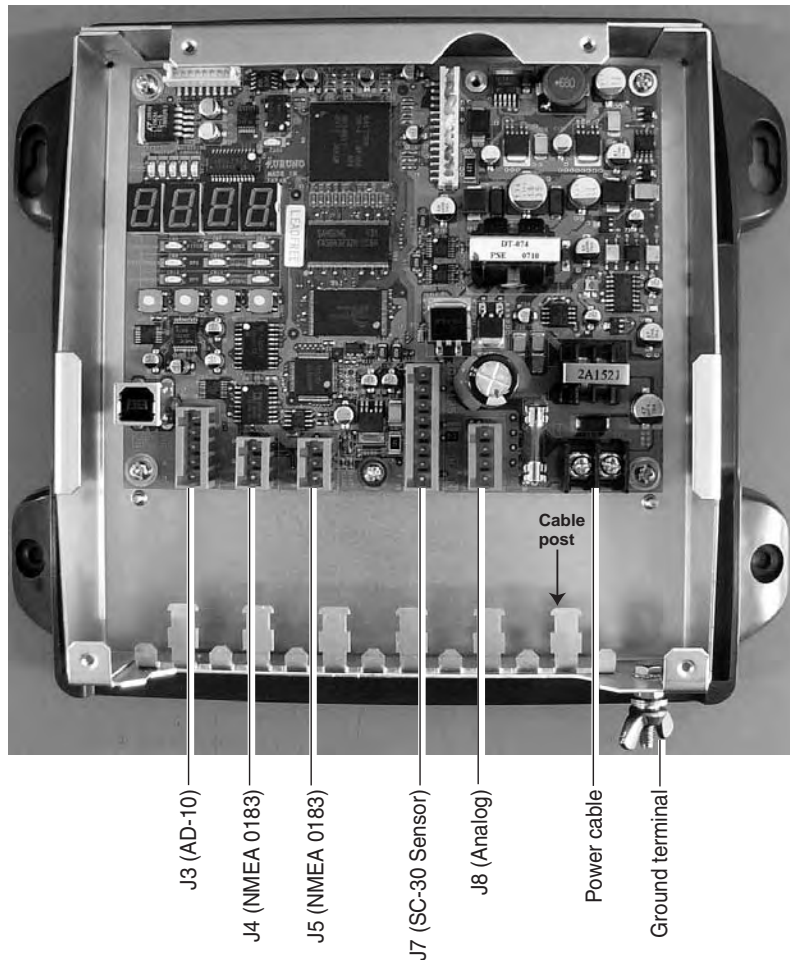

Recommended Cables	
Power cable:	AWG 16-20, and diameter less than 10 mm (JIS* cable DPYC-1.5 or equivalent)
All other cables:	AWG 16-28, shield, twisted, and diameter less than 8 mm (JIS* cable TTYCS-1, TTYCS-4 or equivalent)
* Japan Industry Standard cable	
How to wire WAGO connector	How to fix cable to cable post
<ol style="list-style-type: none"> 1. Insert opener. 2. Press opener. 3. Insert core. 4. Release opener. 	<p>Fix cable to cable post with two cable ties (supplied).</p>

Cable construction

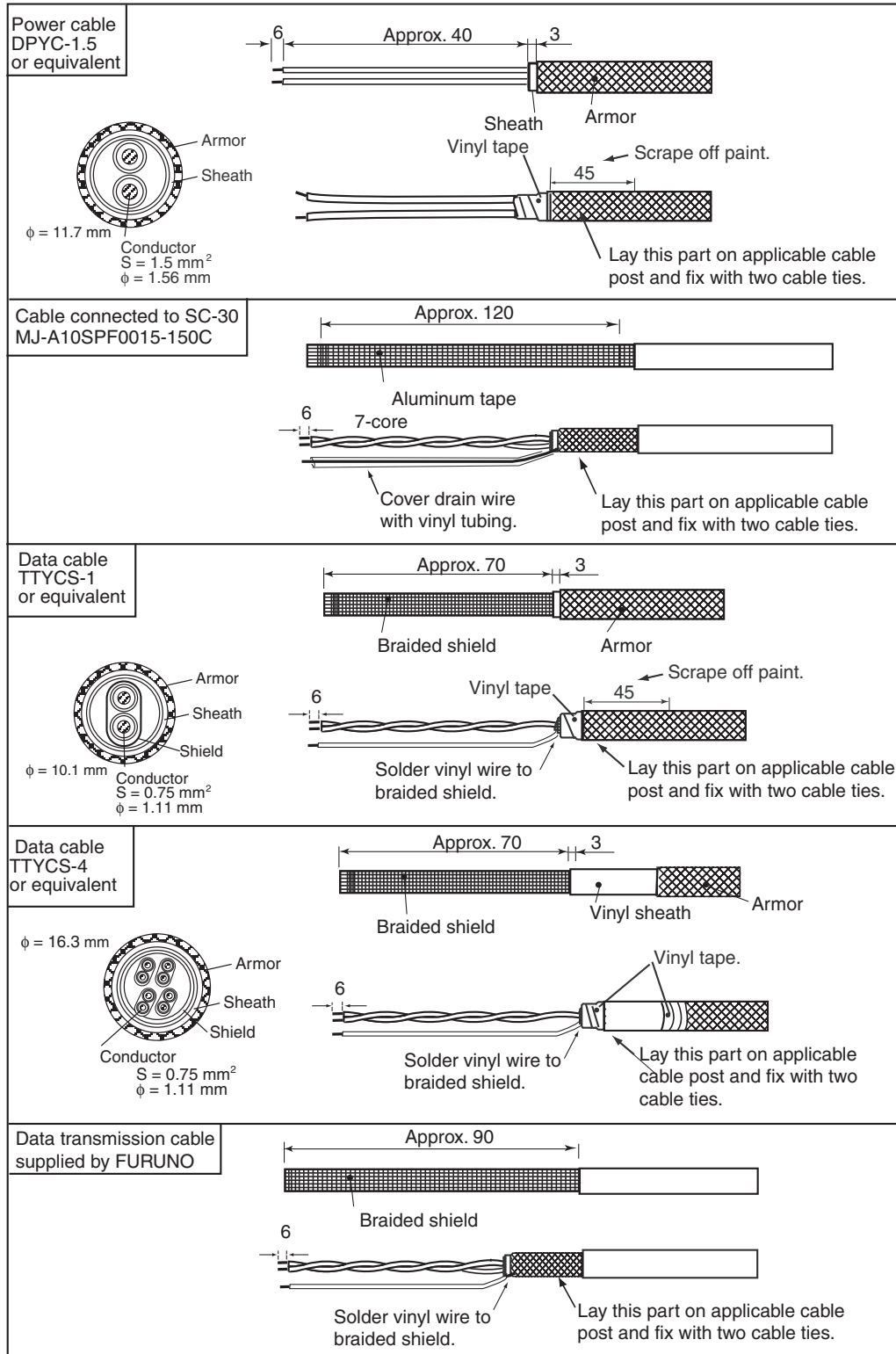

⚠ WARNING

Do not connect this unit to NMEA 2000 bus.

It is intended for one-to-one connection with the SC-30. Connection to an NMEA 2000 bus can result in network trouble and, in the worst case, fire.

3. ADJUSTMENTS

3.1 LEDs and Equipment Status

The six LEDs above the heading indication light, flash or go off according to equipment status.

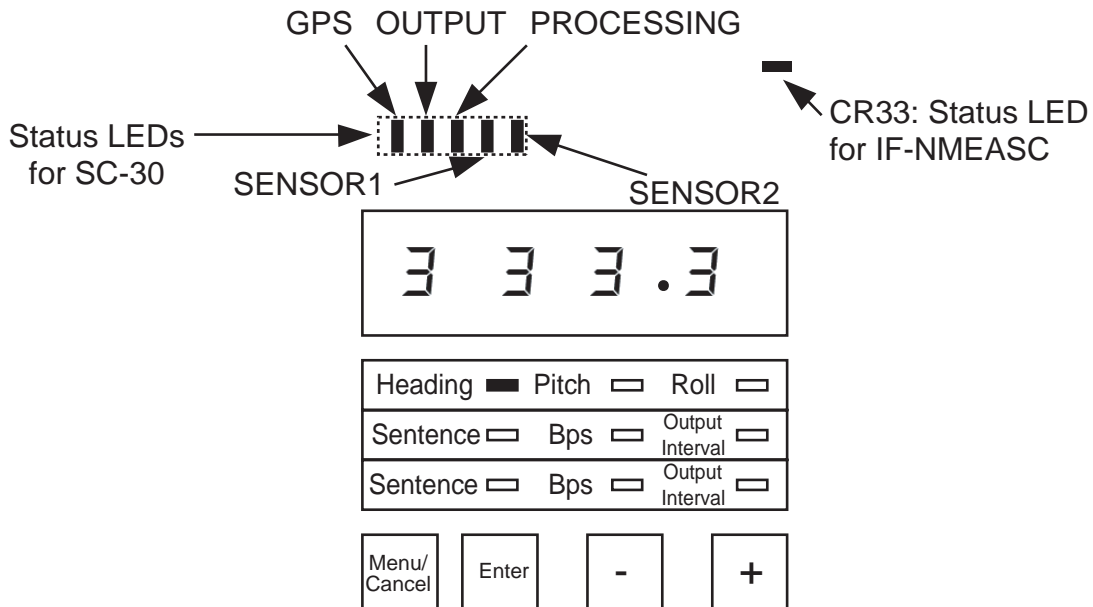

LED state and equipment status

LED	LED state and equipment status
GPS	ON: Both GPS antennas in the SC-30 are receiving from five or more satellites. OFF: One of the GPS antennas is receiving from 3 or fewer satellites.
OUTPUT	ON: All data is output from the SC-30 normally. Flashing: Motion (heading, roll, pitch) is output (heave is fixed at 0, position and speed are normal) by dead reckoning. OFF: Heading output is stopped.
PROCESSING	ON: GPS processor is functioning properly. Flashing: Initializing for GPS. OFF: Not enough satellites received.
SENSOR1	ON: Rate gyro normal on all three axes. OFF: Rate gyro error.
SENSOR2	ON: Acceleration sensor normal on all three axes. OFF: Acceleration sensor error.
CR33	Flashing: Valid NMEA 2000 data is input. ON: No valid NMEA 2000 data is input. OFF: CPU error, or no power.

3.2 Setting Up NMEA Ports

Ports J4 and J5 output data in NMEA 0183 format. Select the data to output from those ports, along with baud rate and output interval. The default settings are as shown in the table below.

Default settings for ports 2 and 3

Port no.	Sentence	Baud rate (bps)	Tx interval (ms)
J4 (Port 2)	HDT (Heading)	4800	100
J5 (Port 3)	ATT (Heading, pitch, roll) HVE (Heave)	38400	25

1. Grasp the cover at its right and left sides, pull the cover outward slightly and then lift the cover to remove it.
2. Open the inner cover and turn on the power.
On the circuit board, find the heading indication, several LEDs, and four operating buttons. The Heading LED is lit.

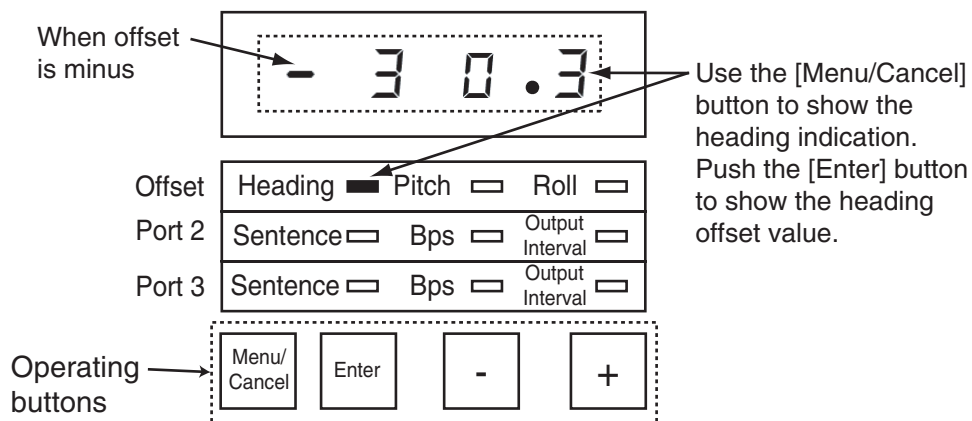

3. Push the [Menu/Cancel] button several times to light the Sentence LED on the Port 2 line.
4. Push the [Enter] button. The Sentence LED starts flashing and the sentence currently selected to output from port 2 is shown with a numeric. See the illustration below for numeric and data sentence.

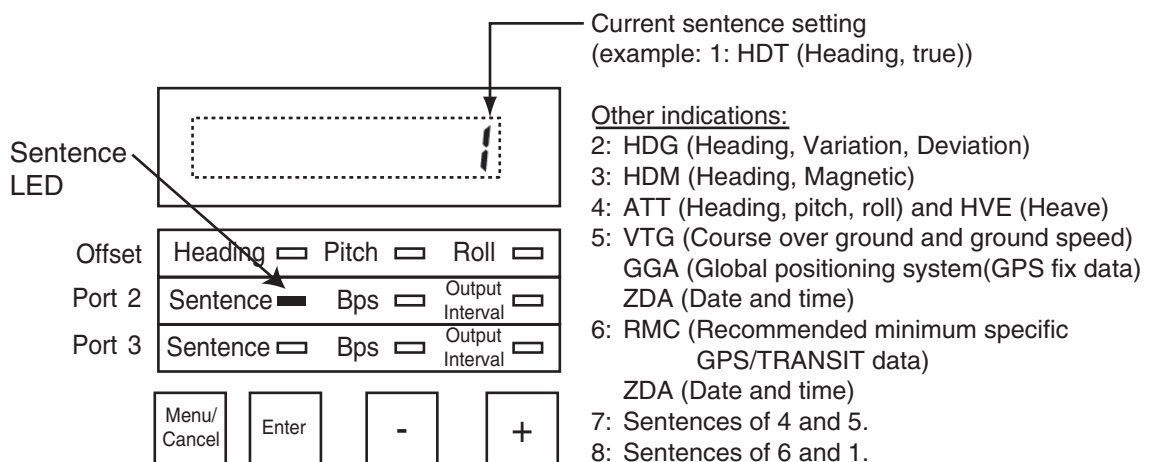

5. Push the [+] or [-] button to display the numeric corresponding to the data sentence you wish to output.
6. Push the [Enter] button. The sentence LED stops flashing.

3. ADJUSTMENTS

7. Push the [Menu/Cancel] button to light the Bps LED on the Port 2 line.

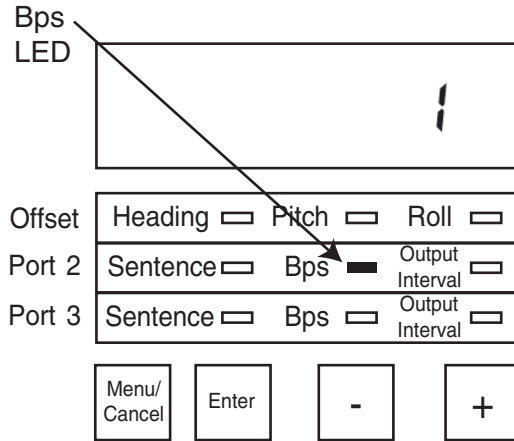

8. Push the [Enter] button. The Bps LED starts flashing and the current bps setting appears.

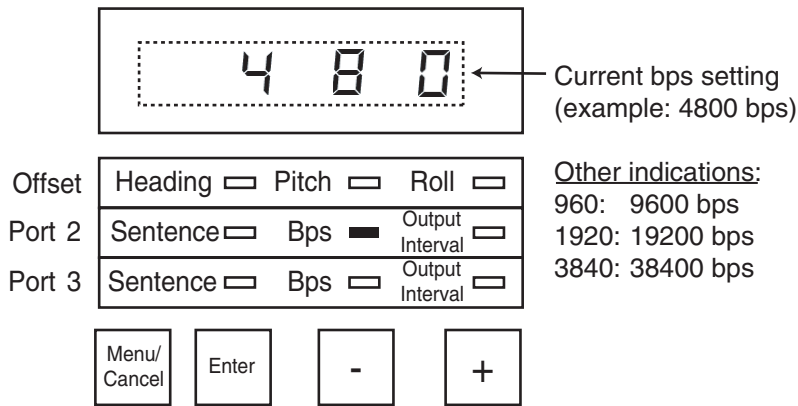

9. Push the [+] or [-] button to select desired baud rate. The choices are 4800, 9600, 19200 and 38400 (bps).

10. Push the [Enter] button. The bps LED stops flashing.

11. Push the [Menu/Cancel] button to light the Output interval LED on the Port 2 line.

12. Push the [Enter] button. The Output Interval LED starts flashing and the current output interval setting appears.

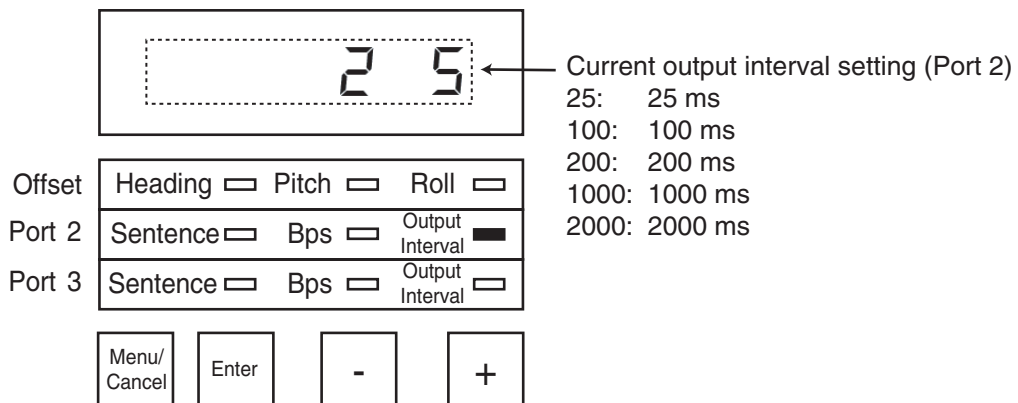

13. Push the [+] or [-] button to select desired output interval, referring to the table below.

Sentence number	Sentence	Output interval (ms)			
		4800 bps	9600 bps	19200 bps	38400 bps
1	HDT	100, 200, 1000, 2000	25, 100, 200, 1000, 2000		
2	HDG	100, 200, 1000, 2000		25, 100, 200, 1000, 2000	
3	HDM	100, 200, 1000, 2000	25, 100, 200, 1000, 2000		
4	ATT, HVE	200, 1000, 2000	100, 200, 1000, 2000		25, 100, 200, 1000, 2000
5	VTG, GGA, ZDA	1000, 2000			
6	RMC, ZDA	1000, 2000			
7	ATT, HVE	200, 1000, 2000	100, 200, 1000, 2000		25, 100, 200, 1000, 2000
	GGA, VTG, ZDA	1000(<1000), 2000		1000(<1000), 2000	
8	HDT	100, 200, 1000, 2000	25, 100, 200, 1000, 2000		
	RMC, ZDA	1000(<1000), 2000			

14. Push the [Enter] button. The output interval LED stops flashing.

15. Set up Port 3 similar to how you did Port 2.

16. Close the inner and outer covers.

3. ADJUSTMENTS

3.3 Heading, Pitch and Roll Offsets

Turn on the IF unit and wait approx. three minutes for the satellite compass to settle. Then, check that heading, pitch and roll data are reasonable. If not, open the unit and enter appropriate offset(s).

1. Open the cover, referring to step 1 in the previous section for the procedure.
2. Open the inner cover.
On the circuit board, find the heading display, LED set, and operating buttons. The Heading LED is lit

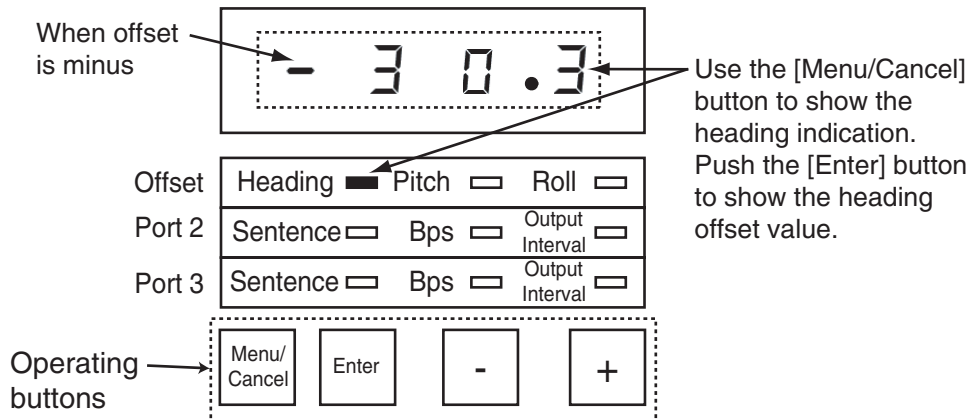

3. Push the [Menu/Cancel] button to light the applicable Offset LED (Heading, Pitch, or Roll) and push the [Enter] button. The selected LED starts flashing and the display shows current offset for item selected.
4. Use the [+] or [-] button to set offset. (You can push and hold down those buttons to speed up the rate of incrementation.)

Range of offset

Heading: $\pm 6^\circ$

Pitch, Roll: $\pm 10^\circ$

5. Push the [Enter] button to finish. The display shows current heading, pitch or roll indication with offset applied. The selected Offset LED stops flashing.
6. Close the inner and outer covers.

4. OPERATION

Normally, no operation is required except to power the unit (from the switchboard). The ST-BY LED on the cover is ON, OFF or flashing according to equipment state.

Flashing: NMEA 2000 data is input

ON: NMEA 2000 data is not input

OFF: Power loss, blown fuse, operation error

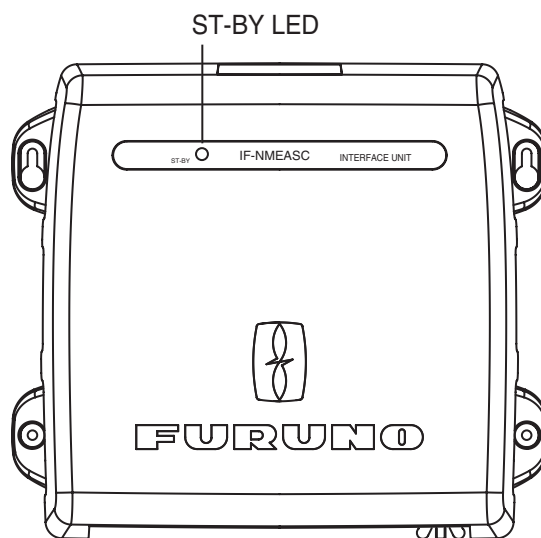

5. MAINTENANCE, TROUBLE-SHOOTING

This chapter provides the information for keeping your unit in good working order.

 WARNING	
	ELECTRICAL SHOCK HAZARD Do not open the equipment. Only qualified personnel should work inside the equipment.

NOTICE
Do not apply paint, anti-corrosive sealant or contact spray to coating or plastic parts of the equipment. Those items contain organic solvents that can damage coating and plastic parts, especially plastic connectors.

5.1 Preventive Maintenance

Regular maintenance is important for good performance. Following the procedures in the table below will help maintain performance

Preventive maintenance

Item	Check point	Remedy
Cabling	Visually check cabling for signs of wear and damage.	Replace damaged cables.
Ground	Check ground wire.	Check that ground wire is tightly fastened. Check ground point for corrosion.
Cover	Cleanliness of cover.	Dust can be removed with a soft cloth. Do not use chemical based cleaners to clean the cover, as they can remove paint and markings and deform the cover.

5.2 Replacing the Fuse

The 2A fuse inside the unit protects it from overcurrent and equipment fault. If the power cannot be turned on, have a qualified technician check the fuse. If the fuse has blown, find out the cause before replacing it. If it blows again, contact your dealer for advice.

Item	Type	Code No,
Fuse	FGMB 125V 2A PBF	000-157-479-10

5.3 Troubleshooting

This section provides simple troubleshooting procedures which the user can follow to restore normal operation. If normal operation cannot be restored, do not attempt to check inside the equipment. There are no user-serviceable parts inside.

Simple troubleshooting procedures

Symptom	Possible trouble	Remedy
Power cannot be turned on	<ul style="list-style-type: none"> Power at switchboard is turned off. Disconnected or damaged power cable. Blown fuse. 	<ul style="list-style-type: none"> Check if power is on at switchboard. Check if power cable is disconnected or damaged. Have a qualified technician check the fuse.
Data is not received from SC-30	<ul style="list-style-type: none"> Signal cable between the SC-30 and this equipment is damaged or disconnected. SC-30 is no received satellite signal. 	<ul style="list-style-type: none"> Check if sensor cable is disconnected or damaged. See the SC-30's operator's manual.
Data is not received at external equipment	<ul style="list-style-type: none"> Disconnected or damaged interconnection cable. Output settings may be incorrect. 	<ul style="list-style-type: none"> Check if cable is disconnected or damaged. Have a qualified technician check the settings.
Heading, pitch or roll data is not correct	<ul style="list-style-type: none"> Offsets entered in this equipment may be incorrect. 	<ul style="list-style-type: none"> Have a qualified technician check the settings.

5.4 Self Test

The self tests check the equipment for proper operation.

Self test 1

This test checks the two GPS receivers, output circuit, processor and two sensors for proper operation.

1. Remove the cover and shield cover from the equipment.
2. Press the [Menu/Cancel] button several times to show "- - -.1" on the display. The LED lamps one by one in order, the Output Interval LED in the Port 3 line, and then the equipment goes into the test mode.

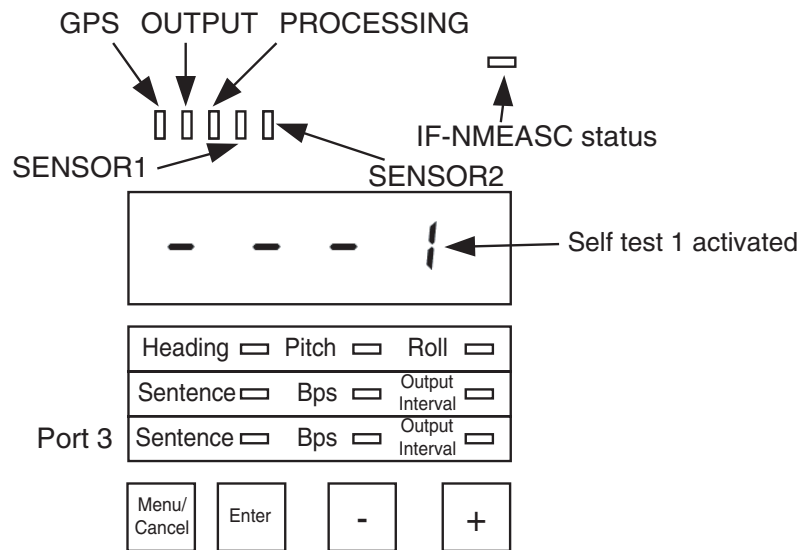

3. Press the [Enter] button, and the test proceeds as below.
 - GPS receivers are checked. The GPS lamp lights if the receivers are normal.
 - Communication between this equipment and the SC-30 is checked. The OUTPUT LED lights if normal.
 - The CPU memory access is checked. The PROCESSING LED lights if normal.
 - The rate gyro is checked. The SENSOR1 LED lights if normal.
 - The acceleration sensor is checked. The SENSOR2 LED lights if normal.

When the test is finished, the nine LEDs below the display flash, and then the display shows "End.1".
4. Press the [Enter] button to return to self test 1.

Self test 2

This test checks this unit's processor and output for proper operation.

1. With the display showing " - - - .1", push the [Menu/Cancel] button. The display shows " - - - 2".

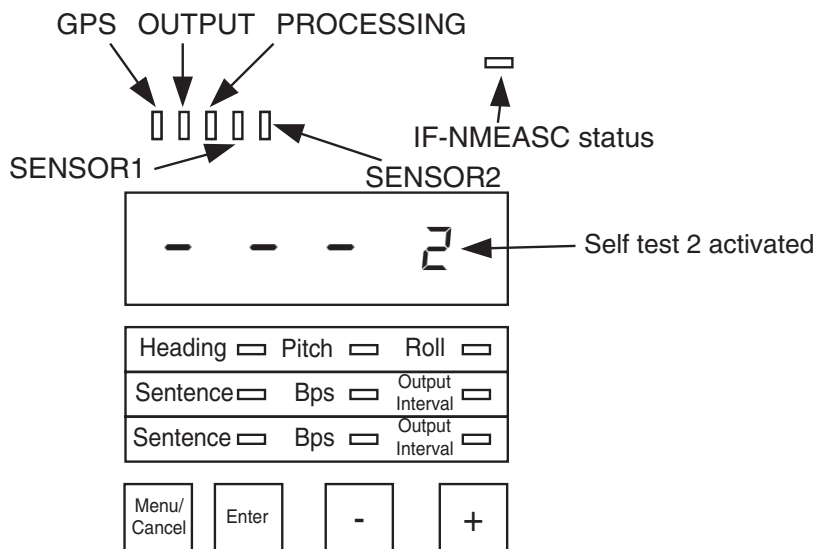

2. Press the [Enter] button to start the test.
If the results are normal all LEDs light. Then, the nine LEDs below the display flash and the display shows "End.2".
3. Press the [Enter] button to return to the self test 2 display.

5.5 Memory Clear

The memory can be cleared to restore the default settings for the NMEA ports. Note that offsets are not cleared.

1. Hold down the [Menu/Cancel] button together with the [+] button until the display shows " - CLR". At this time all Status and Settings LEDs are on.

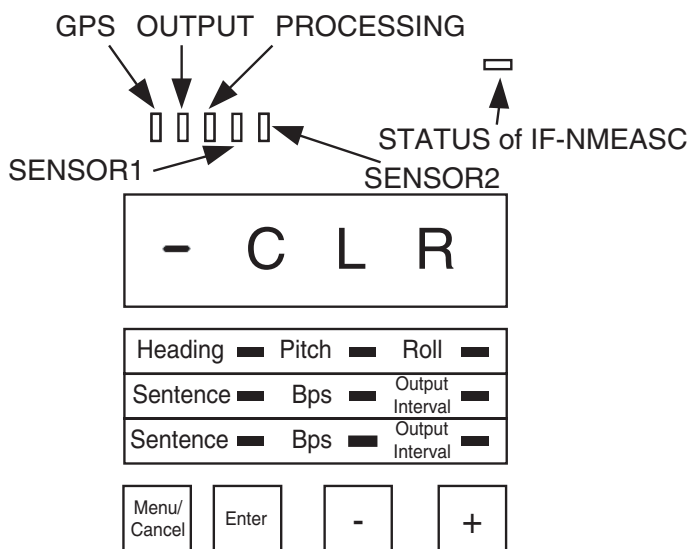

2. Press the [Enter] button to clear the memory and restore all default settings. "END C" appears upon completion.
3. After the memory is cleared, press the [Menu/Cancel] button to show the heading.

5. MAINTENANCE, TROUBLESHOOTING

This page is intentionally left blank.

SPECIFICATIONS OF INTERFACE UNIT IF-NMEASC

1 INPUT PORT

NMEA 2000*, for data I/O between FURUNO satellite compass SC-30

* NMEA 2000 is a registered trademark of the National Marine Electronics Association.

2 OUTPUT PORT

NMEA 0183: Two ports (HDT, HDG, HMD, ATT*, HVE*, VTG, GGA, RMC, ZDA)

* ATT (heading, pitch, roll) and HVE (heave) are FURUNO proprietary sentences.

AD-10: One port

Analog: One port (pitch, roll)

3 NMEA 0183 OUTPUT INTERVAL

HDT, HDG, HDM, ATT, HVE: 25ms, 100 ms, 200 ms, 1 s, 2 s

VTG, GGA, RMC, ZDA: 1 s, 2 s

4 POWER SUPPLY

12-24 VDC: 1.0-0.6 A

5 ENVIRONMENTAL CONDITIONS

5.1 Ambient Temperature -15°C to +55°C

5.2 Humidity Less than 95% at 40°C

5.3 Waterproofing IP20

5.4 Vibration - From 2 Hz to 5 Hz to up to 13.2 Hz with an excursion of $\pm 1 \text{ mm} \pm 10\%$
-13.2 Hz to 100 Hz with a constant maximum acceleration of 7 m/s^2

6 COATING COLOR

N2.5

表 1 TABLE 1

寸法区分 (mm) DIMENSION	公差 (mm) TOLERANCE
$L \leq 50$	± 1.5
$50 < L \leq 100$	± 2.5
$100 < L \leq 500$	± 3

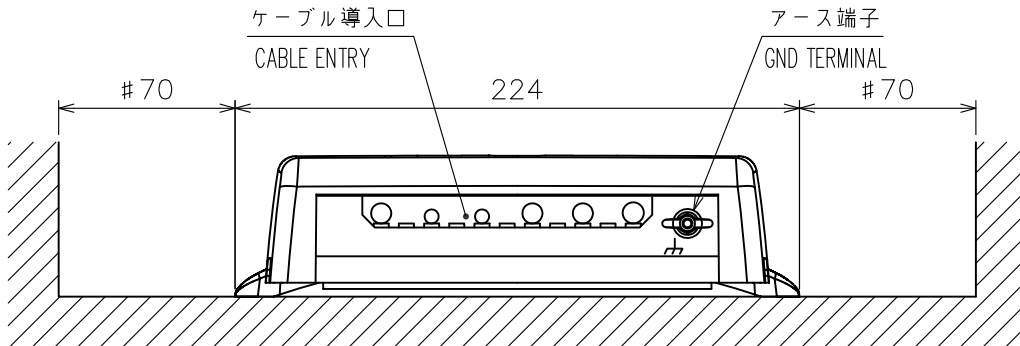
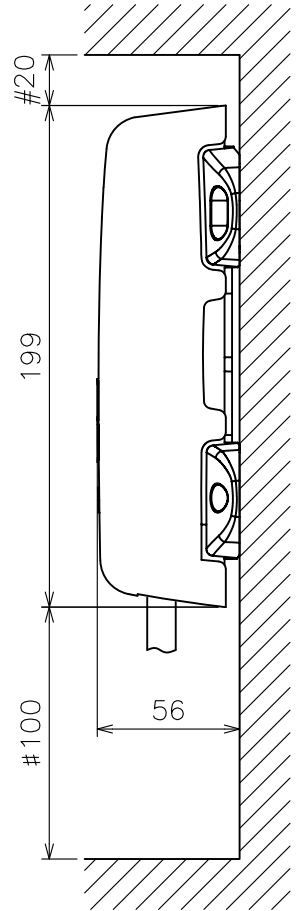
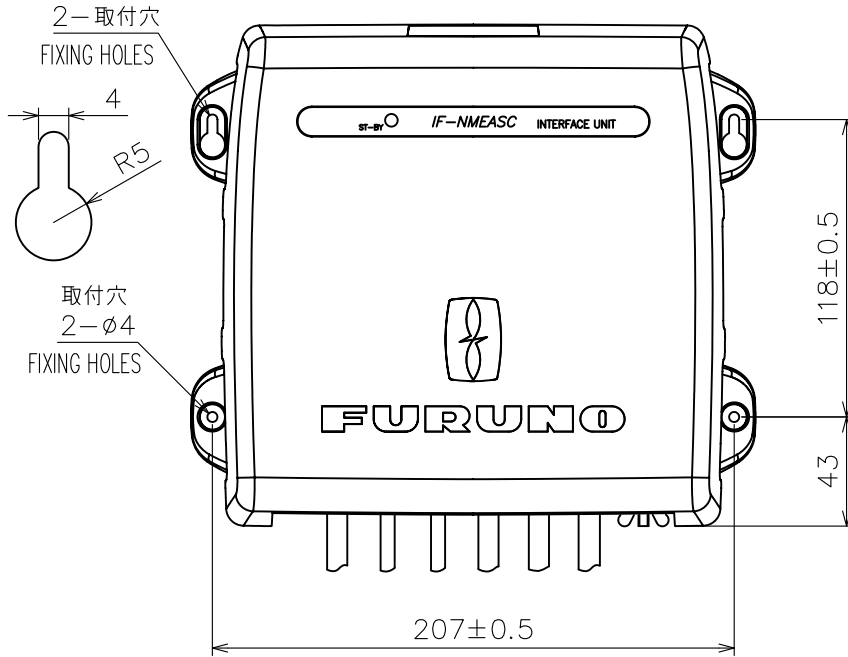
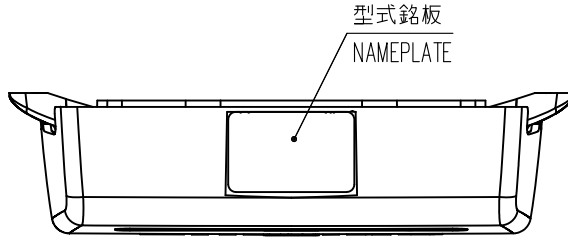

注 記

- 1) 指定外の寸法公差は表1による。
- 2) #印寸法は最小サービス空間寸法とする。
- 3) 取付用ネジはトラスタップピンネジ呼び径3×10を使用のこと。

NOTE

1. TABLE 1 INDICATES TOLERANCE OF DIMENSIONS WHICH IS NOT SPECIFIED.
2. #: MINIMUM SERVICE CLEARANCE.
3. USE TAPPING SCREWS $\phi 3 \times 10$ FOR FIXING THE UNIT.

DRAWN	Jul. 13 '07 T.YAMASAKI	TITLE	IF-NMEASC
CHECKED	Jul. 13 '07 T.TAKENO	名称	インターフェイスユニット
APPROVED	Jul. 23 '07 R.Esumi	SC-30	外寸図
SCALE	1/3	MASS	1.0 ±10% kg
DWG.No.	C7265-G02-A	REF.No.	20-030-130G-1
		NAME	
		INTERFACE UNIT	
		OUTLINE DRAWING	

This page is intentionally left blank.

ECF

(Elemental Chlorine Free)

The paper used in this manual
is elemental chlorine free.

FURUNO ELECTRIC CO., LTD.

9-52 Ashihara-cho,
Nishinomiya, 662-8580, JAPAN

Telephone : +81-(0) 798-65-2111

Fax : +81-(0) 798-65-4200

• FURUNO Authorized Distributor/Dealer

All rights reserved. Printed in Japan

Pub. No. OME-72651-A1

(DAMI) IF-NMEASC

A : DEC. 2007

A1 : JAN. 28, 2008



* 0 0 0 1 6 6 8 9 9 1 0 *